

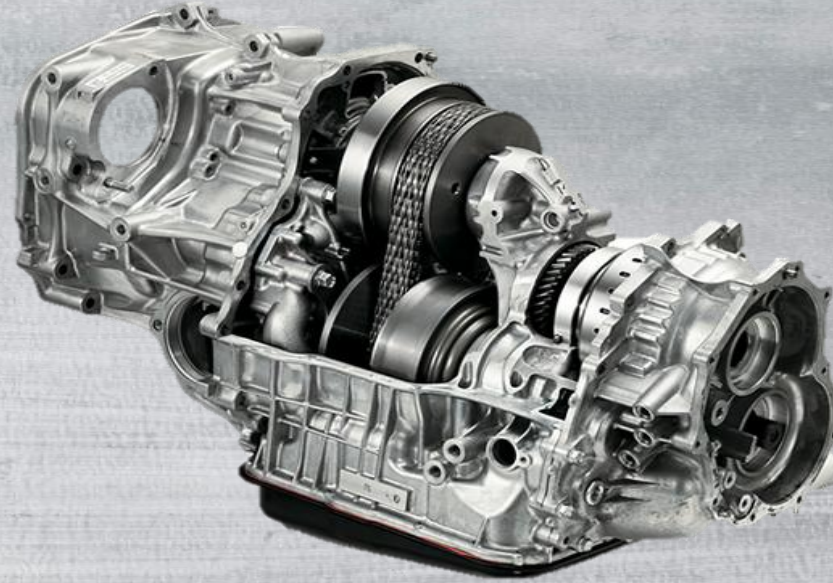

# Subaru Lineartronic CVT Introduction



***Presented by:***  
***Mike Souza***  
***ATRA Senior***  
***Research Technician***



*Lineartronic CVT Webinar ©2015 ATRA. All Rights Reserved.*



*your source for engineered solutions*





SEAL AFTERMARKET PRODUCTS



# Introduction

The Lineartronic CVT is an automatic continuously variable all wheel drive longitudinal transaxle. It provides an infinite step-less change in ratios from 2.37 to 1 in the highest range all the way to 0.39 to 1 in overdrive range.

This AWD transaxle is equipped behind the new sporty Subaru Boxer engine in some models.

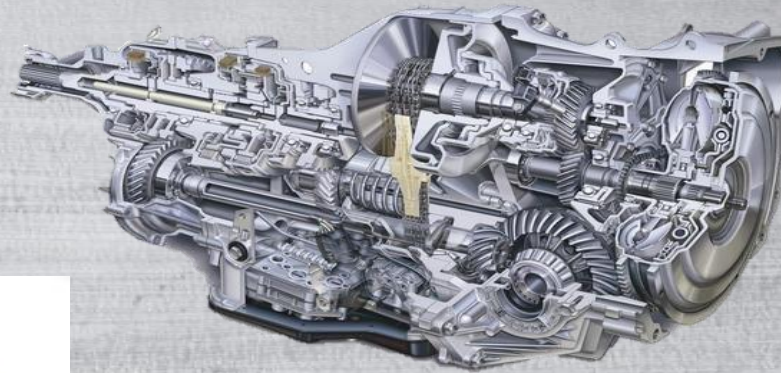

Lineartronic

All Wheel Drive



Subaru Boxer Engine



*your source for engineered solutions*





SEAL AFTERMARKET  
PRODUCTS



# Introduction

The Lineartronic-CVT can be found in these vehicles.

2010-15 Exiga F/AWD H4 2.0L / 2.5L TR580 Gen II / TR690 Gen I (European)

2011-15 Forester AWD H4 2.0L / 2.5L TR580 Gen II / TR690 Gen I

2010-15 Impreza AWD H4 1.6L / 2.0L TR580 Gen II / H4 2.0L TR690 Gen I

2009-15 Legacy AWD H4 2.0L / 2.5L H6 3.6L TR690 Gen I / H4 2.5L TR580 Gen II

2009-15 Outback AWD H4 2.5L TR580 Gen II / H6 3.6L TR690 Gen I

2014-15 WRX AWD H4 2.0L TR580 Gen II

2013-14 XV Crosstrek AWD H4 2.0L TR580 Gen II

There are two versions of this transmission Gen I TR690 and Gen II TR580.

The more compact Gen II is 100mm shorter and 15% lighter than the Gen I.

For the most part in this webinar we will be covering the Gen I models.



*your source for engineered solutions*





SEAL AFTERMARKET  
PRODUCTS



# Gen I TR690 / Gen II TR580

## Generation I TR690



## Generation II TR580

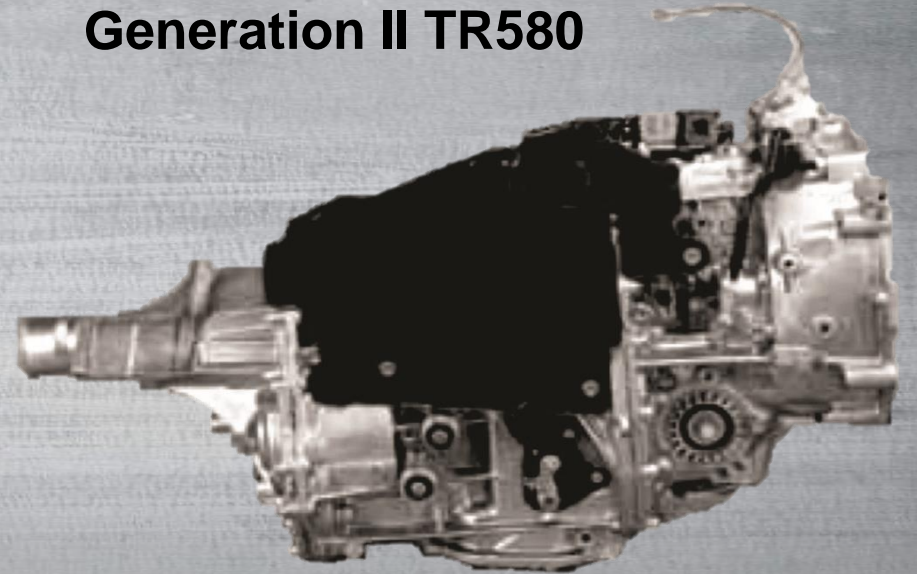

*your source for engineered solutions*





## Gen I TR690 / Gen II TR580

There are 6 major differences with Gen II in comparison to the Gen I.

1. The Forward and Reverse shift mechanism is on the input side of power flow.
2. The Pulleys are not rotating in Park or Neutral (less engine parasitic drag).
3. The weight and load of the vehicle directly affects the Secondary Pulley operation.
4. Fail-safe gear ratio is common for Primary Up or Primary Down solenoid failures.
5. The Forward and Reverse Clutches can be heard activating until the Clutch Plates expand from heat.
6. The Valve Body assembly is located on the top of the transmission under the cover.



*your source for engineered solutions*





SEAL AFTERMARKET PRODUCTS



# Gen II TR580

Top Cover

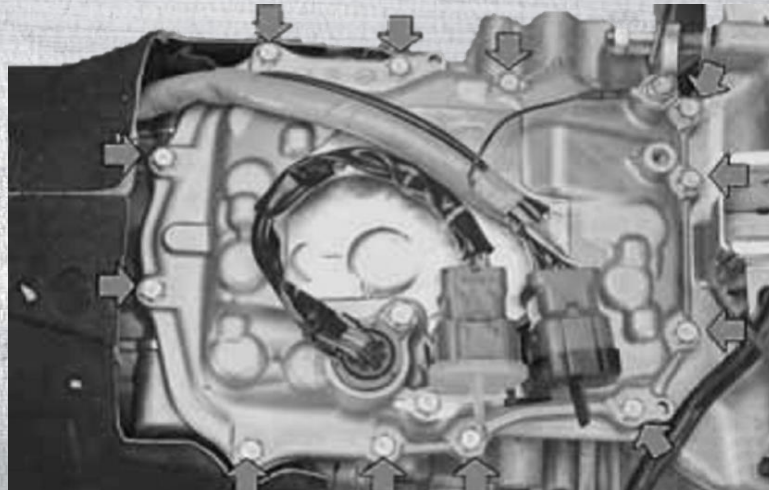
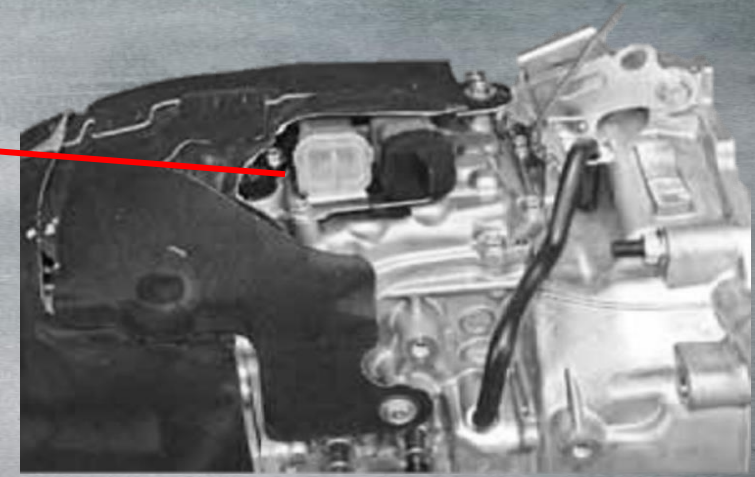

Valve Body

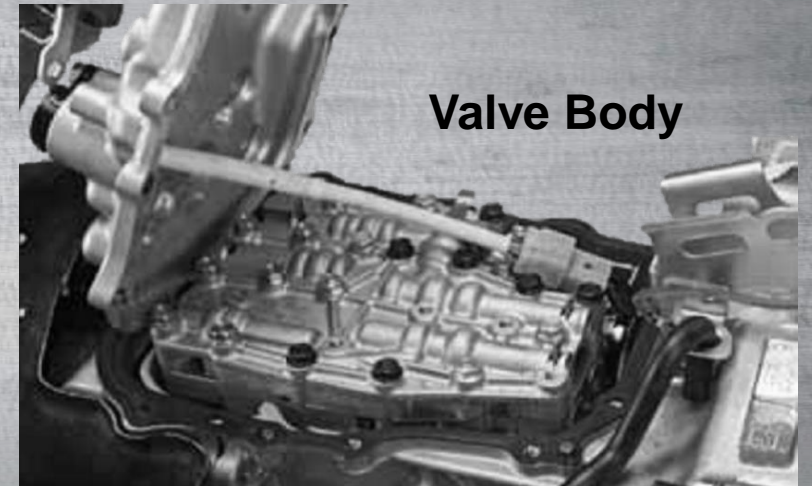

*your source for engineered solutions*





SEAL AFTERMARKET PRODUCTS



# Gen II TR580

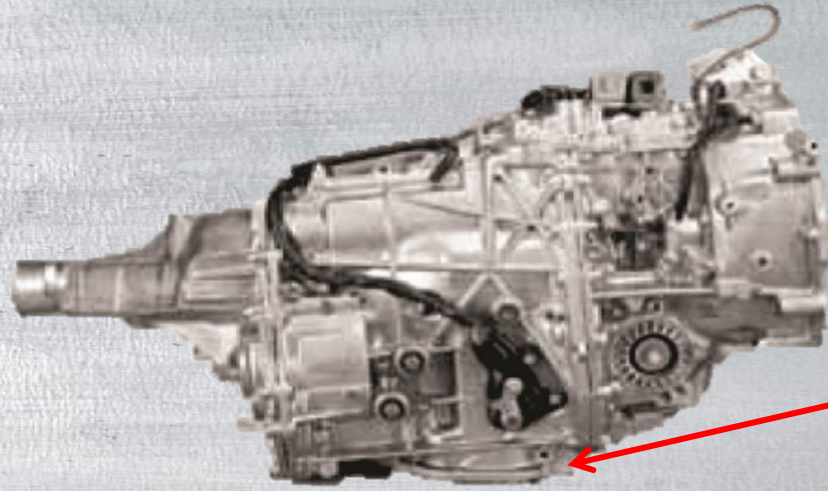

Shallow Pan

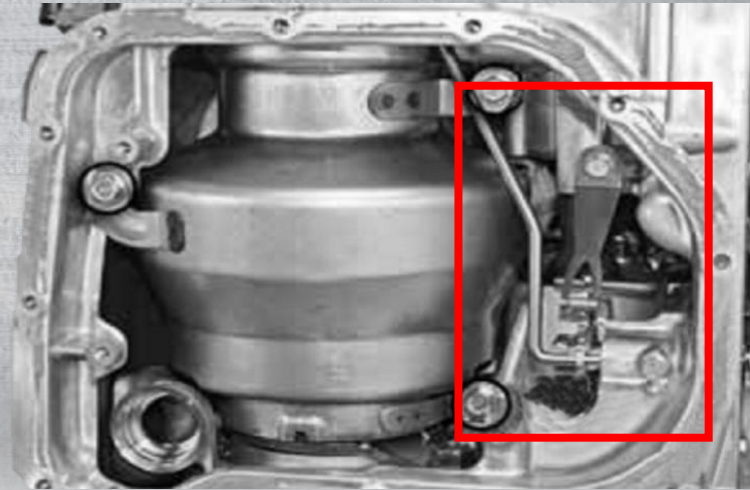
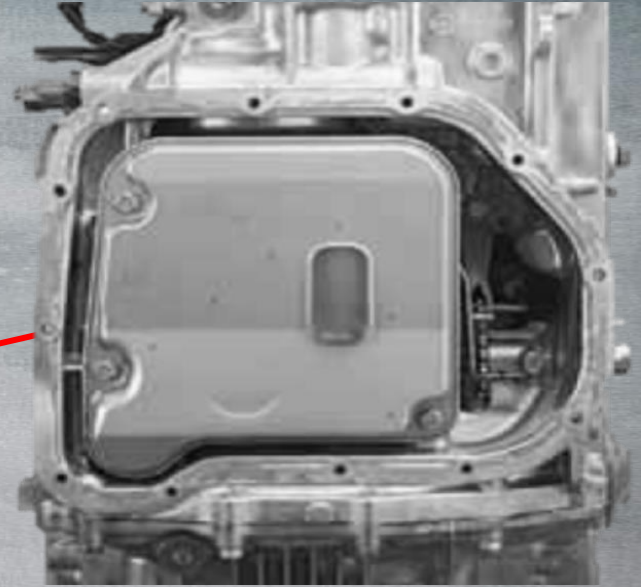

Linkage



*your source for engineered solutions*





SEAL AFTERMARKET  
PRODUCTS



## How Does It Work

The driver can control up and downshifts through paddle switches located on the steering wheel and a console mounted floor shifter in the manual gate.

There are 3 shift control modes the driver can select which include automatic, manual and temporary manual.

Automatic mode provides gear ratios from 2.37 to 1 in the highest range on take off to 0.39 to 1 in the lowest range in the overdrive ratio in the Drive range.

The Lineartronic will step through preset ratios similar to a conventional automatic shifting transmission.

In the less aggressive mode (Intelligent), the transmission changes through six preset ratios.

Using the paddle switches on the steering wheel in Sport (“Sharp”) mode, and the transmission will change up to eight preset ratios.

The paddle shifter provides control of the ratios, and a 3.5-inch LCD screen between the analog speedometer and tachometer shows which ratio is selected.



*your source for engineered solutions*







SEAL AFTERMARKET  
PRODUCTS



## How Does It Work

Manual mode provides the following 6 gear ratios:

1st 2.18:1 (2.37:1 in Auto Mode)

2nd 1.45:1

3rd 1.03:1

4th 0.77:1

5th 0.58:1

6th 0.40:1 (0.39:1 in Auto Mode)

Reverse gear in all modes is 2.09:1.



The highest ratio during take off is in the Manual Mode while the lowest overdrive ratio is in the Automatic Mode.

Manual mode is controlled by placing the console shifter into the manual gate and using the up and down paddle buttons on the steering wheel.



Temporary manual mode can be accomplished anytime while in automatic mode by activating the paddle shift buttons on the steering wheel.



*your source for engineered solutions*





SEAL AFTERMARKET  
PRODUCTS

**TK** TOLEDO  
TRANS-KIT

**GEARS**  
FOR THE TRANSMISSION REBUILDING INDUSTRY

**WIT**  
WHATEVER IT TAKES  
TRANSMISSION PARTS, INC

## How Does It Work

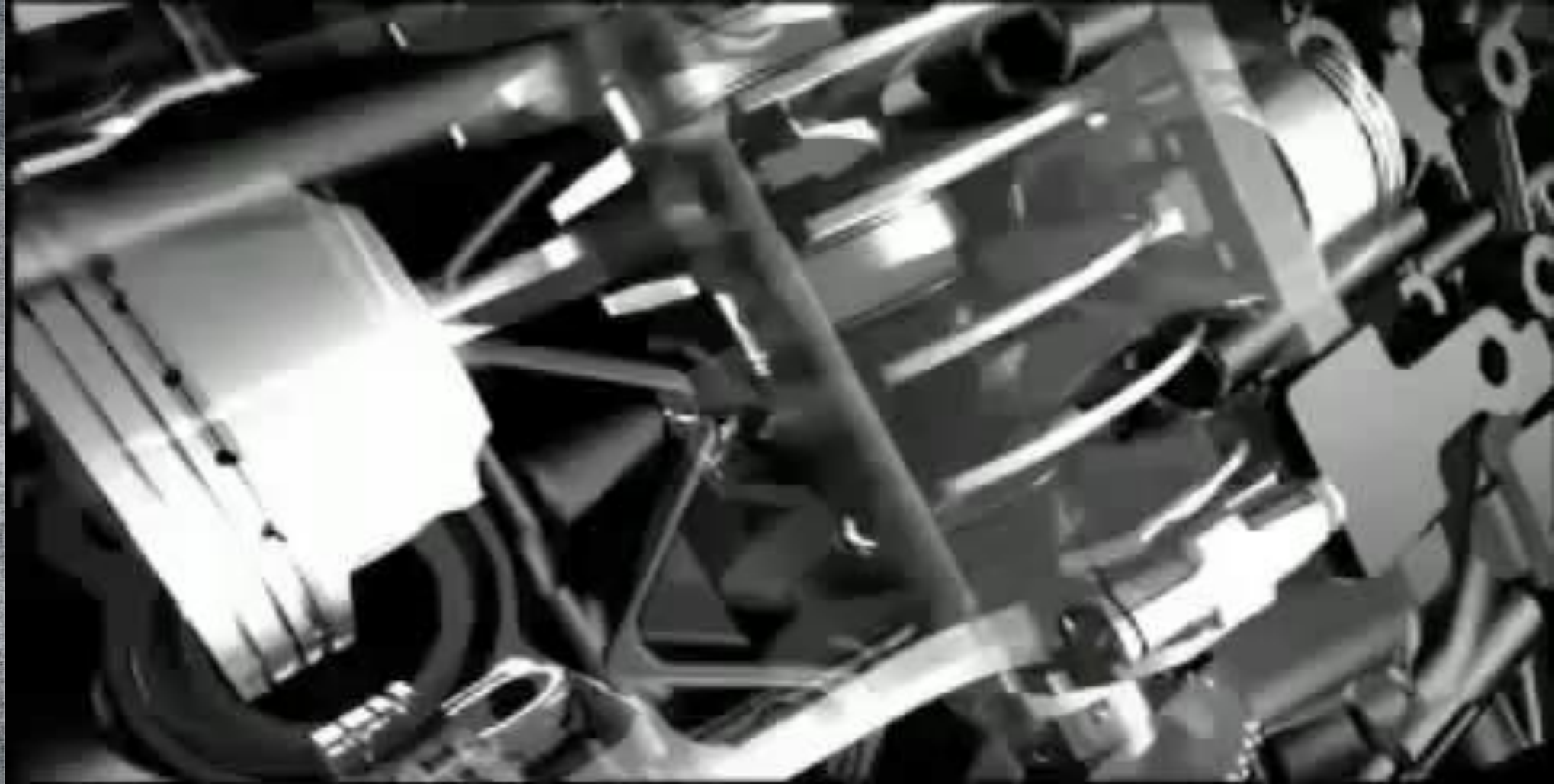

**TK** TOLEDO  
TRANS-KIT

*your source for engineered solutions*

  
SEAL AFTERMARKET  
PRODUCTS



SEAL AFTERMARKET  
PRODUCTS



## Pulley Operation

**Secondary Pressure (Line) is the same in both Pulleys at all times.**

**The purpose of secondary pressure is to squeeze the pulleys together to clamp the pulleys against the chain and keep it from slipping.**

**The primary pulley receives engine power from the input clutch.**

**The TCM adjusts the signal to the primary-up solenoid to change the ratio of the transmission. This alters the position of the primary-up control valve, which increases primary pressure in the ratio chamber.**

**The added pressure in the ratio chamber squeezes the primary pulley together, making the chain ride up in the pulley, increasing the effective pulley diameter.**

**At the same time, it forces the secondary pulley apart, reducing the effective diameter of the driven pulley. This raises the effective gear ratio toward an overdrive range.**



*your source for engineered solutions*





SEAL AFTERMARKET PRODUCTS



# Pulley Operation

1st 2.18:1 (2.37:1 in Auto Mode)

The Primary Pulley receives Engine Power from the Input Clutch

Low Gear Ratio Take Off

Secondary Pressure (Line) is the same in both Pulleys at all times keeping clamping pressure to hold the Chain from slipping

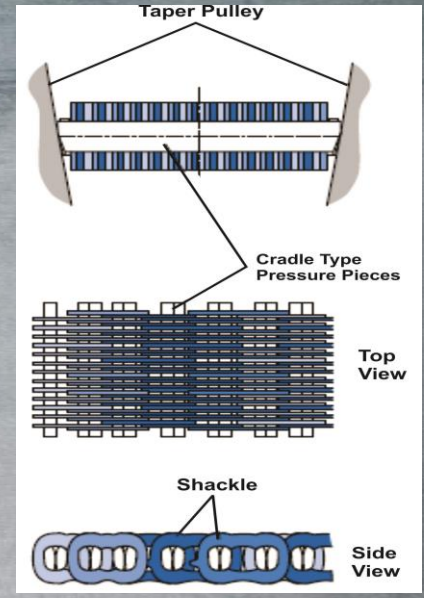
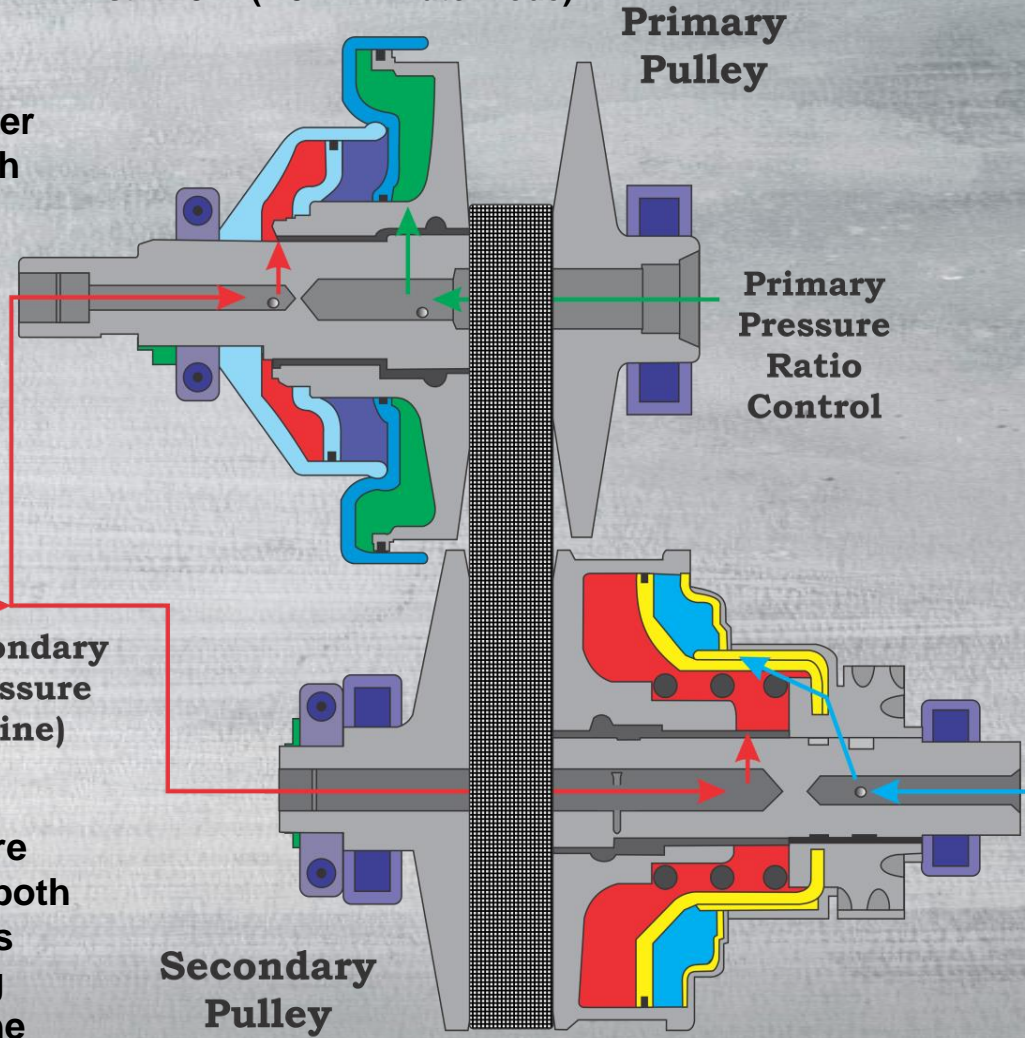

*your source for engineered solutions*





SEAL AFTERMARKET PRODUCTS



# Pulley Operation

6th 0.40:1 (0.39:1 in Auto Mode)

The Primary Pulley receives Engine Power from the Input Clutch

High Gear Ratio Overdrive

Secondary Pressure (Line)

Secondary Pressure (Line) is the same in both Pulleys at all times keeping clamping pressure to hold the Chain from slipping

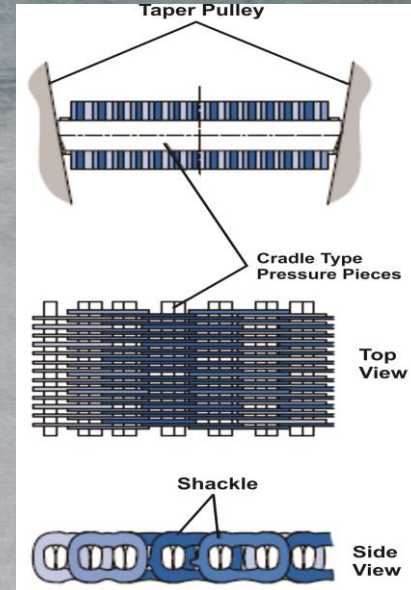
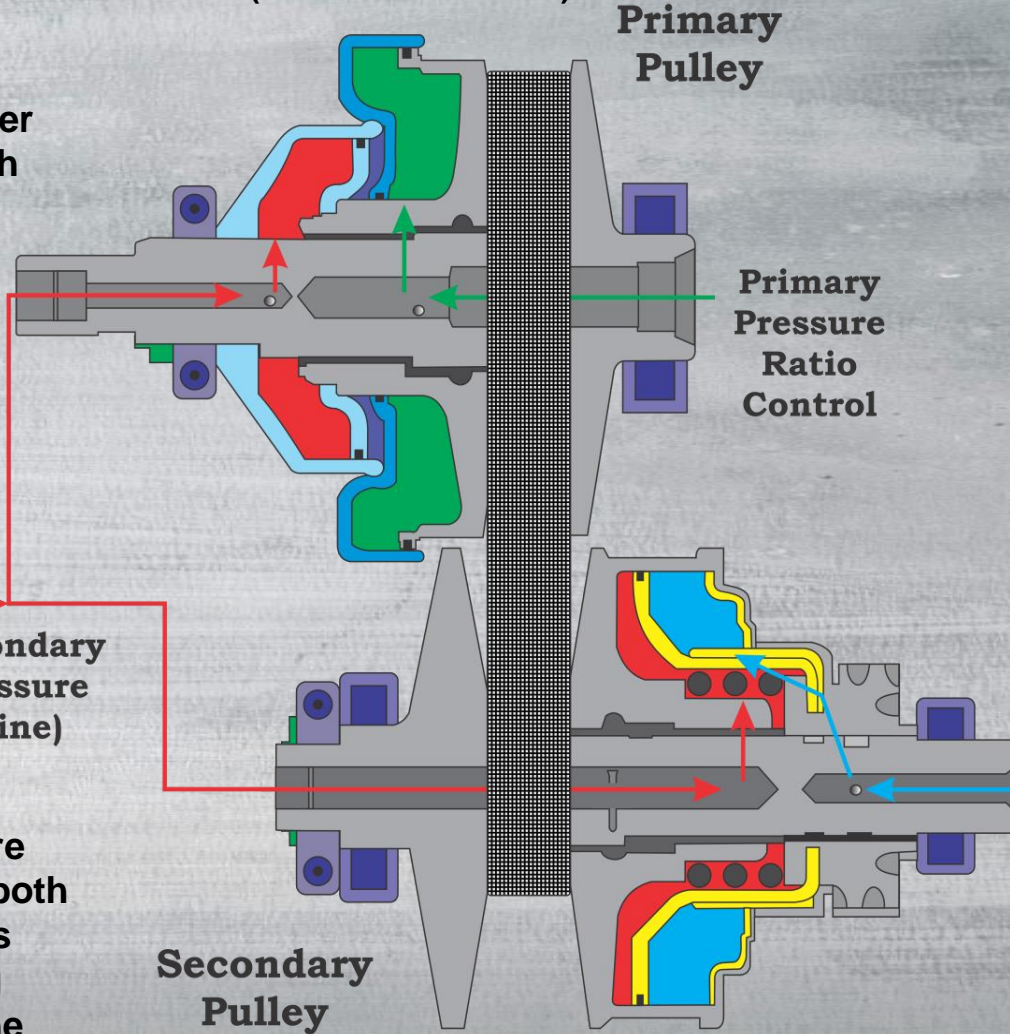

*your source for engineered solutions*





SEAL AFTERMARKET  
PRODUCTS



## Pulley Operation

As the vehicle slows, the TCM sends a signal to the primary-down solenoid. The oil from the solenoid controls the primary-down valve, which dumps pressure through the ratio switch valve.

As pressure drains from the ratio chamber in the primary pulley, spring force takes over in the secondary pulley. The spring squeezes the secondary pulley closed, effectively increasing its diameter.

At the same time, it forces the primary pulley open, effectively reducing the front pulley's diameter. This puts the transmission back into low gear range.

The ratio changes up and down are smooth. This helps keep the engine RPM at the prime speed for power and fuel efficiency.



*your source for engineered solutions*





SEAL AFTERMARKET  
PRODUCTS



# Construction

The Lineartronic CVT is divided into four sections.

- Torque Converter Bellhousing
- Transmission Main Case
- Intermediate Case
- Extension Housing

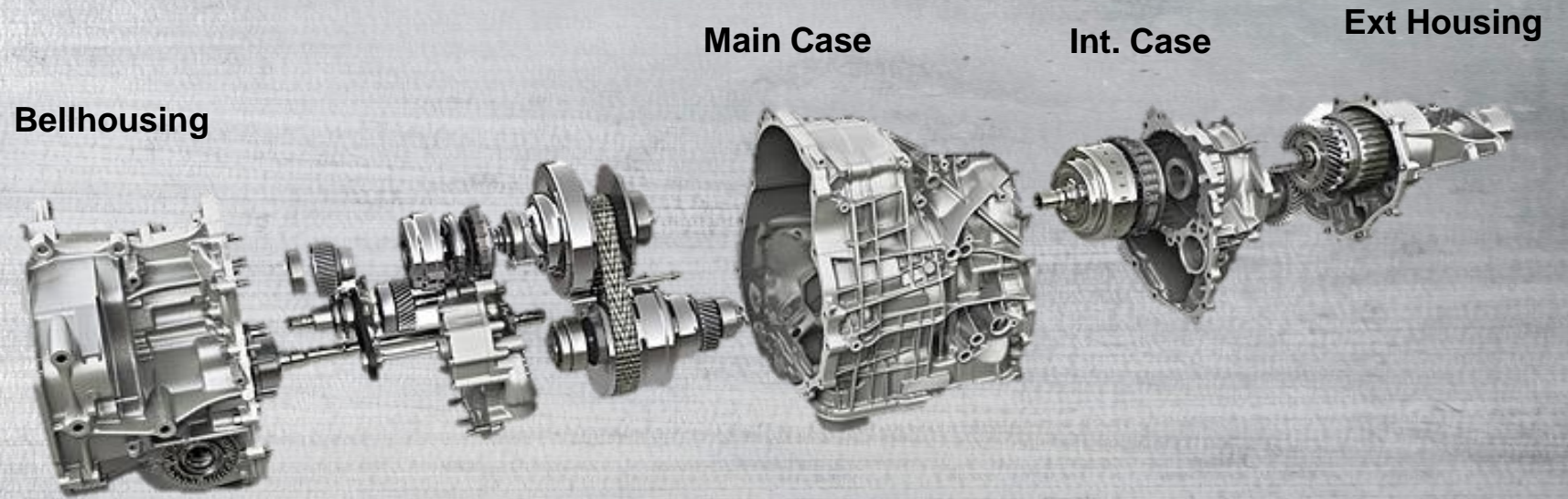

*your source for engineered solutions*





SEAL AFTERMARKET PRODUCTS



# Construction

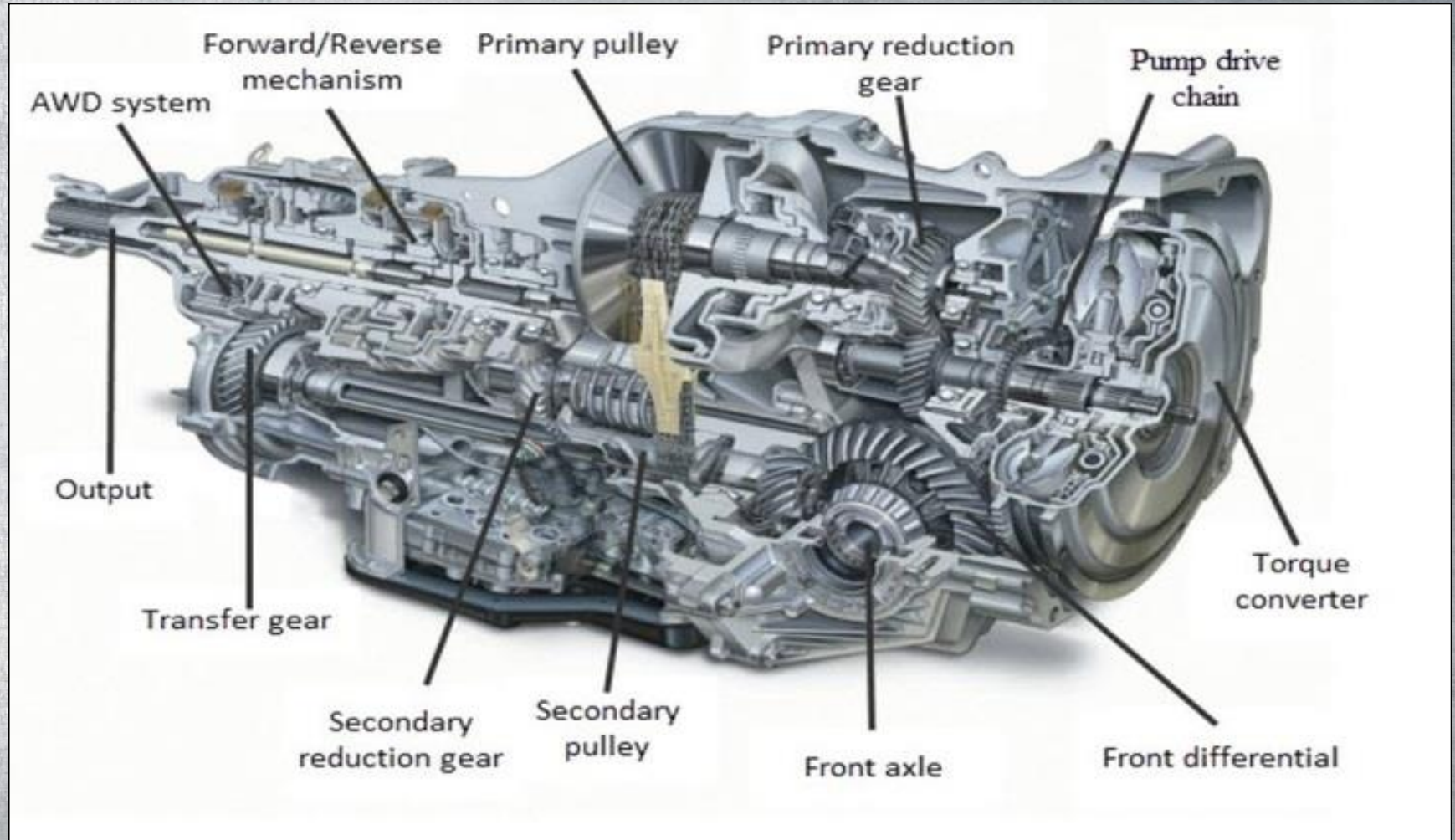

*your source for engineered solutions*







SEAL AFTERMARKET  
P R O D U C T S



## Power Flow

While the engine is being started, the rotating speed of the oil pump is not turning fast enough to provide the efficient amount oil pressure to engage the input clutch. This keeps the transmission from creating any resistance to engine during startup.

After engine RPM reaches more than 400 rpm, the primary and secondary pulleys are charged with oil and then the input clutch is engaged. This prevents the pulleys from turning until the clamping pressure on the chain has been provided.

Once the input clutch is engaged, engine power is delivered to the pulleys in the transmission through the reduction gear.

When pressure begins to increase, the secondary pressure chambers of the primary and secondary pulleys are filled to provide efficient clamping force on the chain. The proper amount of pressure keeps the proper alignment of the chain throughout all gear ratio changes.



*your source for engineered solutions*





SEAL AFTERMARKET  
PRODUCTS

**TK** TOLEDO  
TRANS-KIT

**GEARS**  
FOR THE TRANSMISSION REBUILDING INDUSTRY

**WIT**  
WHATEVER IT TAKES  
TRANSMISSION PARTS, INC

# Power Flow

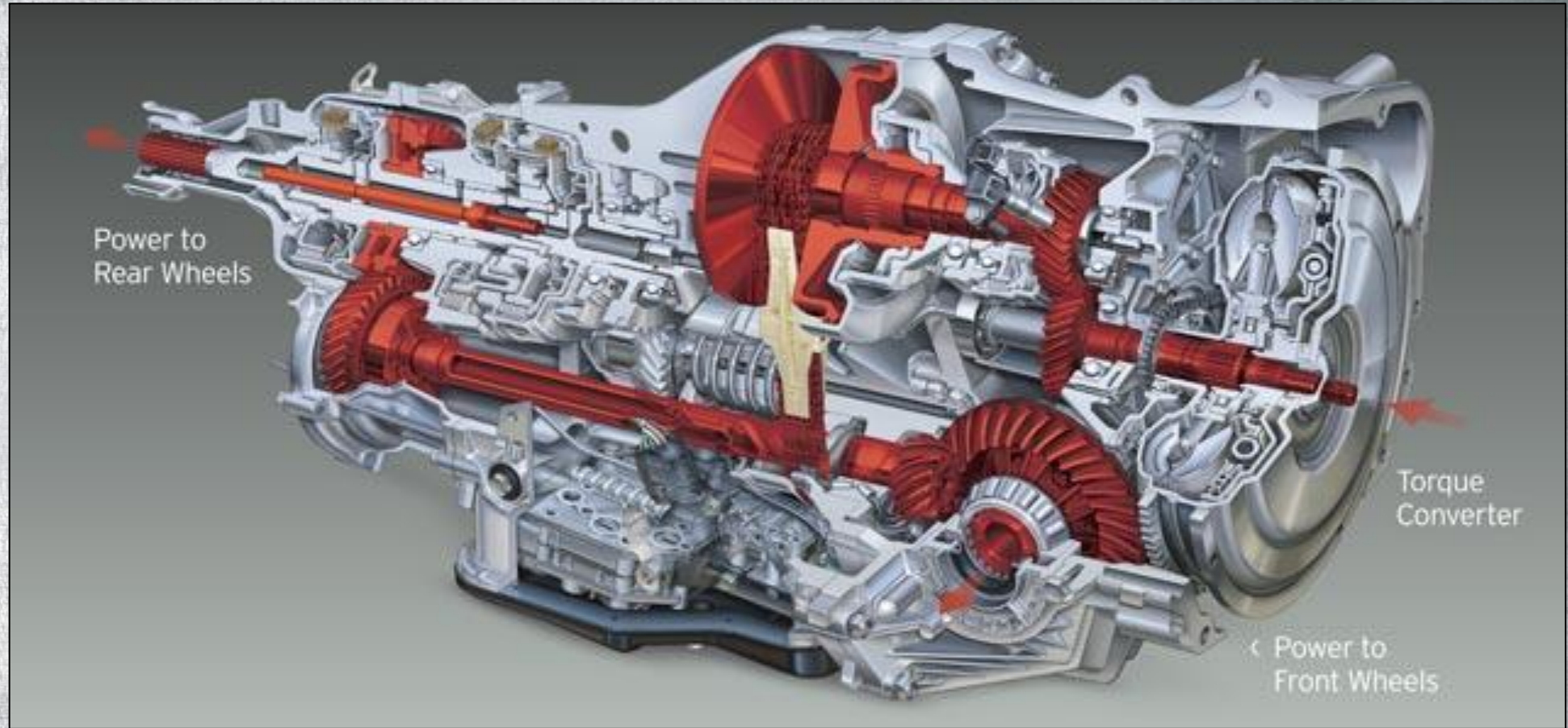

**TK** TOLEDO  
TRANS-KIT

*your source for engineered solutions*

SEAL AFTERMARKET  
PRODUCTS



# Power Flow

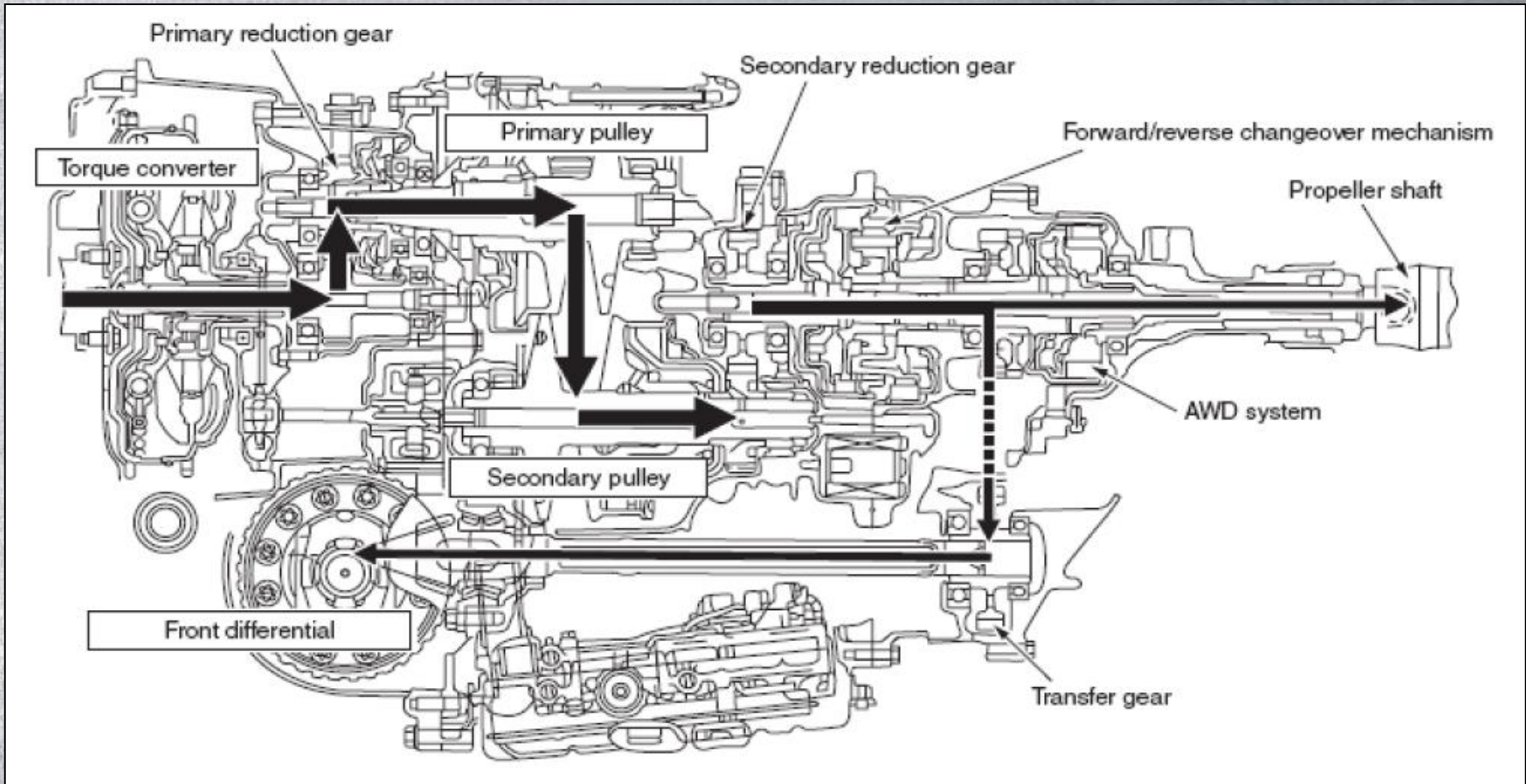

*your source for engineered solutions*





SEAL AFTERMARKET PRODUCTS



# Power Flow

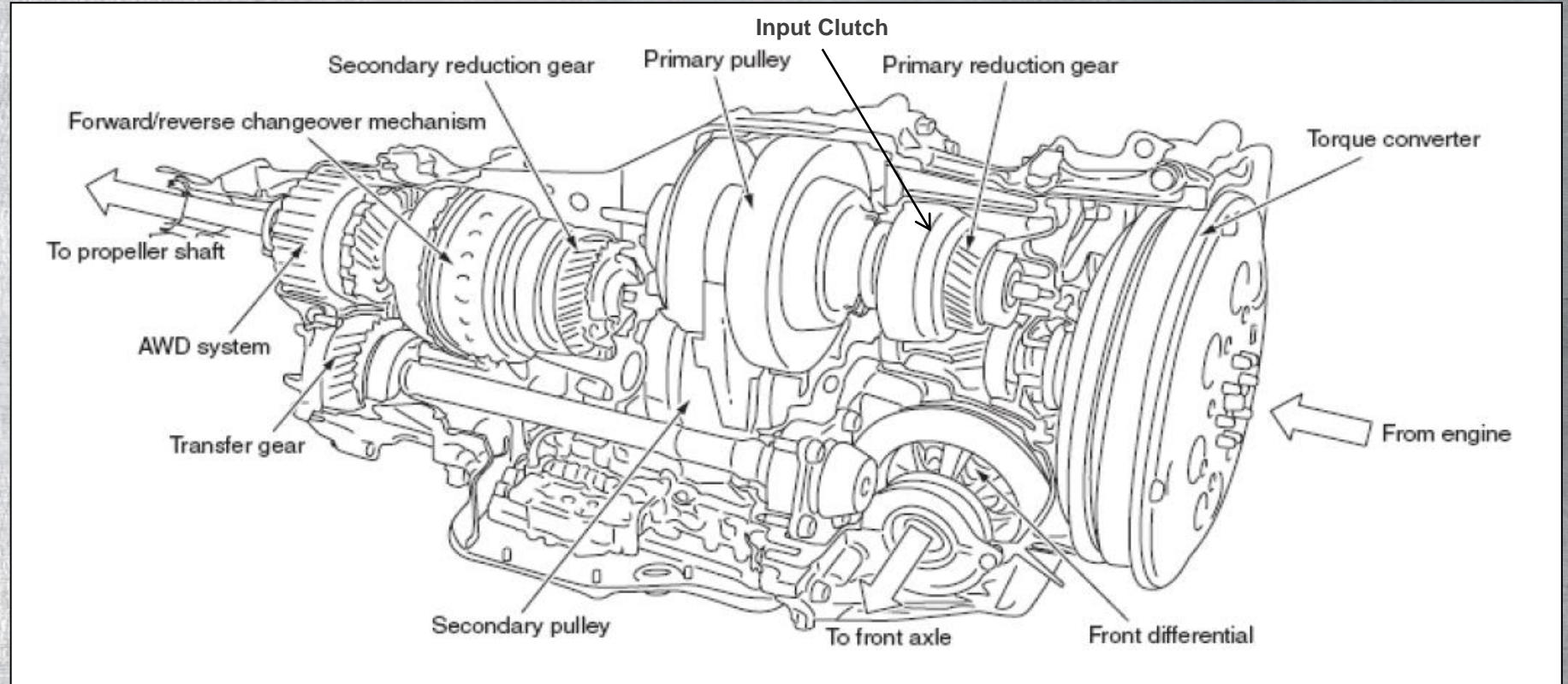

*your source for engineered solutions*





SEAL AFTERMARKET PRODUCTS



# Power Flow

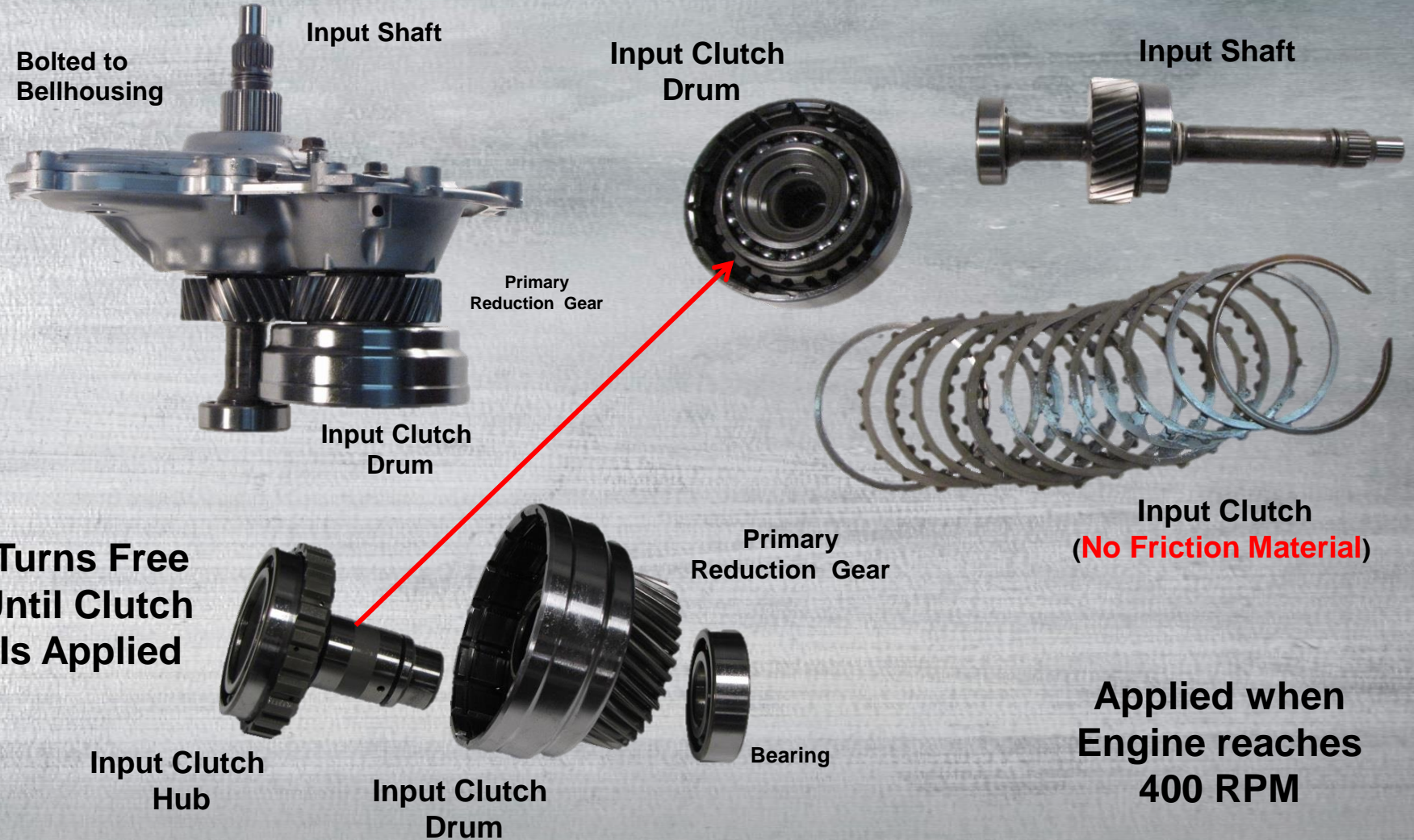

*your source for engineered solutions*





SEAL AFTERMARKET PRODUCTS



# Power Flow

## Forward & Reverse Apply

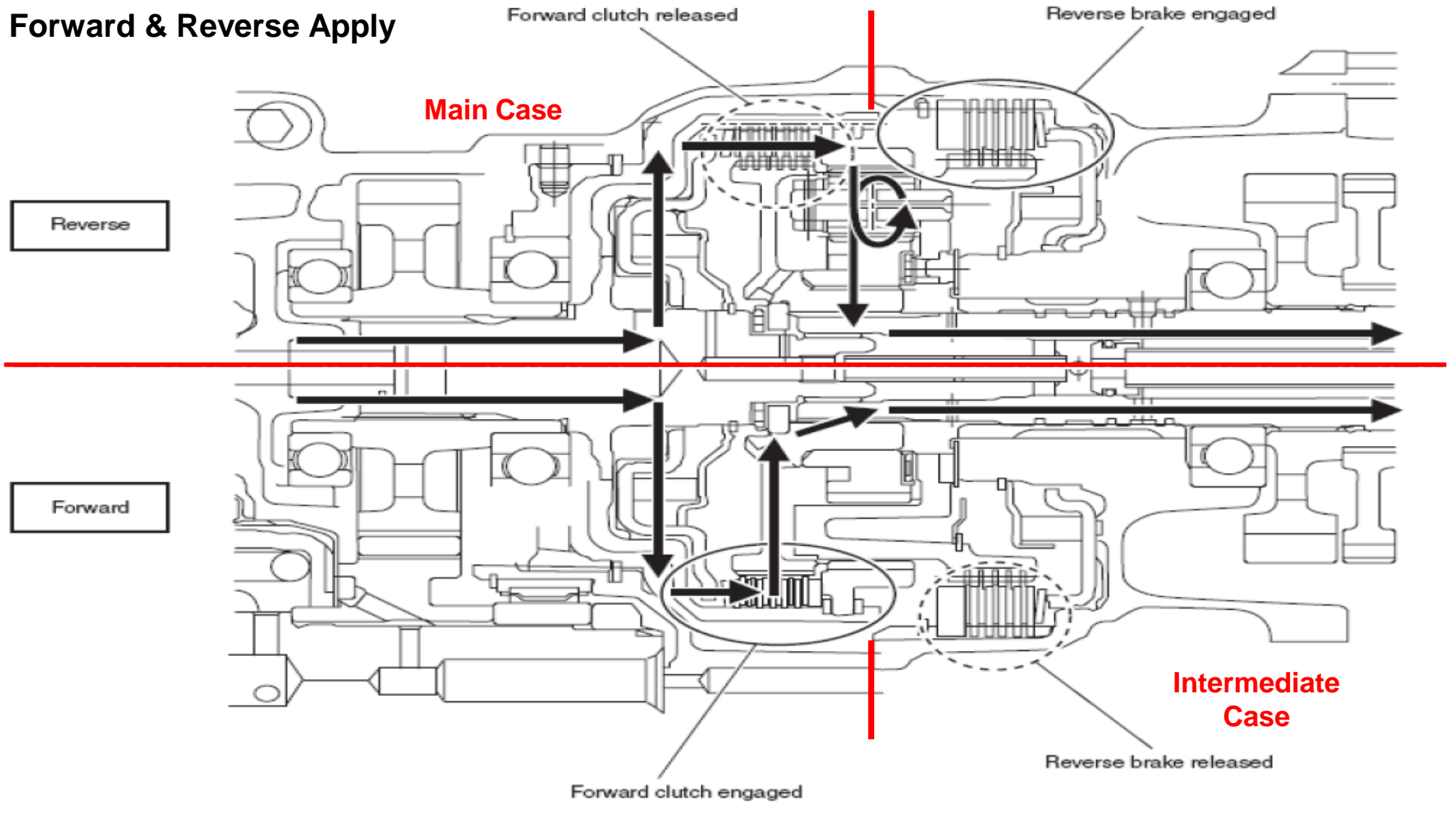

*your source for engineered solutions*





# Power Flow

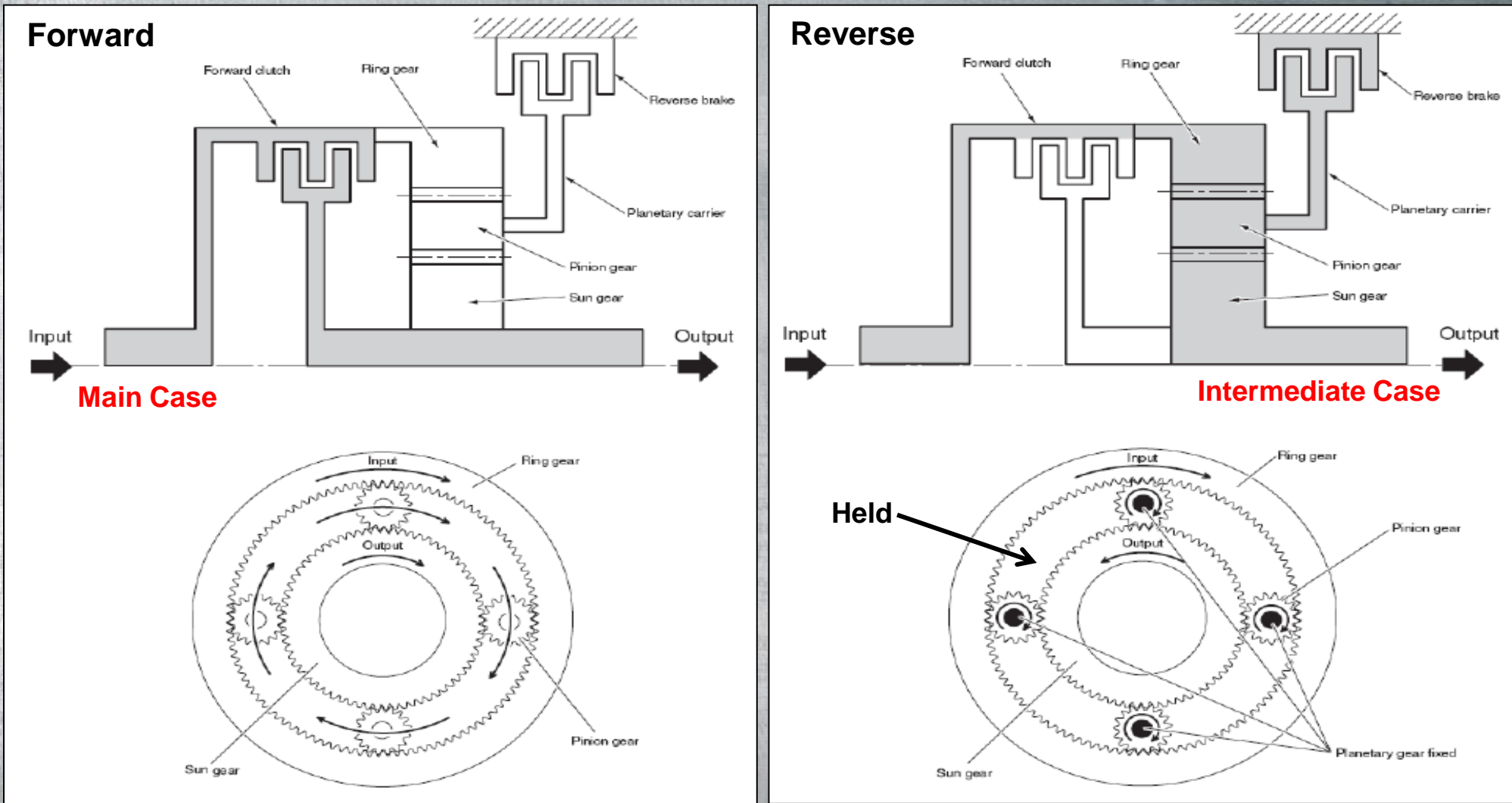

*your source for engineered solutions*





SEAL AFTERMARKET  
PRODUCTS

TK TOLEDO  
TRANS-KIT

GEARS  
FOR THE TRANSMISSION REBUILDING INDUSTRY

WIT  
WHATEVER IT TAKES  
TRANSMISSION PARTS, INC

## Forward Clutch Assembly

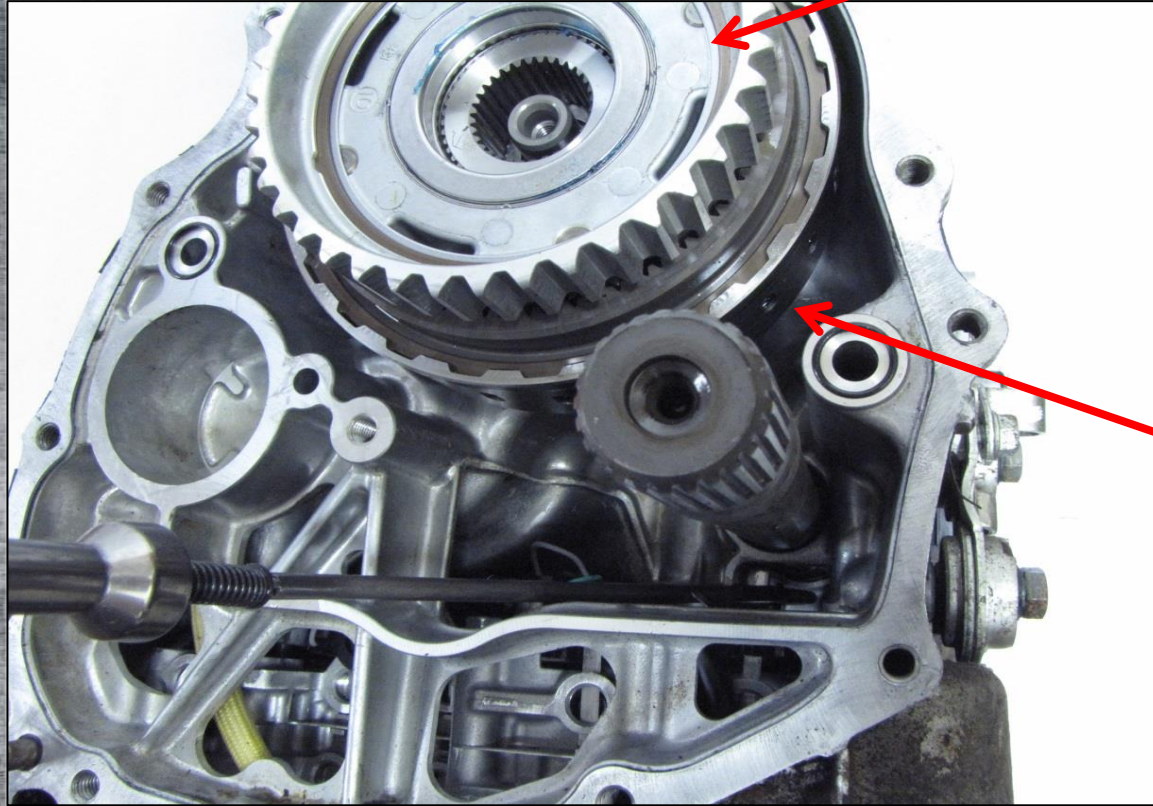

Rear View of Main Case

## Power Flow

Planet Assembly

Front View of Intermediate Case



Forward Clutch Drum

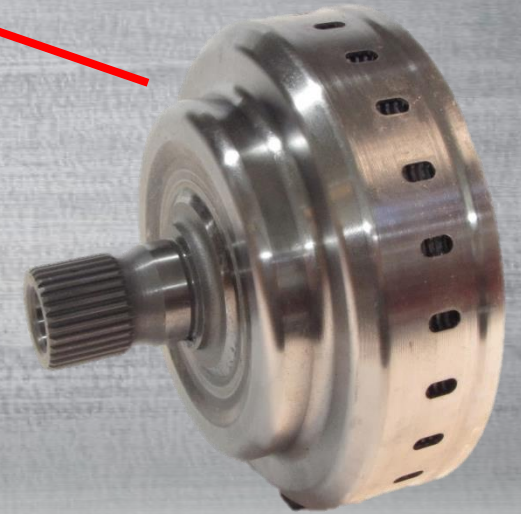

TK TOLEDO  
TRANS-KIT

*your source for engineered solutions*

SEAL AFTERMARKET  
PRODUCTS





SEAL AFTERMARKET PRODUCTS



## Forward Clutch Assembly

## Power Flow

Planet Assembly

Sun Gear

Forward Clutch Drum



Ring Gear



Forward Clutch  
(Friction Material)



*your source for engineered solutions*





SEAL AFTERMARKET PRODUCTS



# Power Flow

## Reverse Clutch Assembly

When applied the reverse clutch holds the planetary carrier stationary.

Planet Assembly Splines Here

Front View of Intermediate Case



Reverse Clutch

Front View of Intermediate Case

Lube Filter

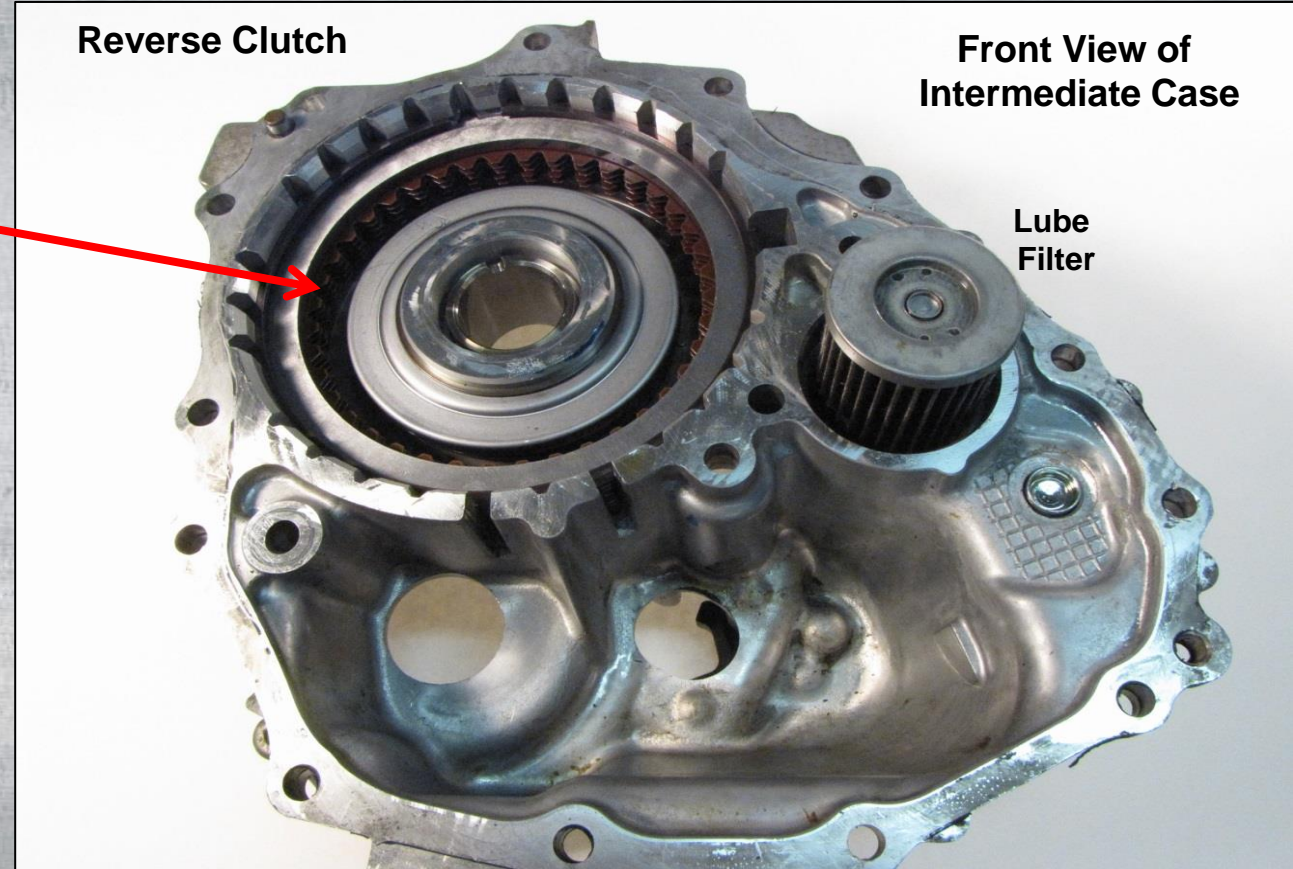

*your source for engineered solutions*





SEAL AFTERMARKET PRODUCTS



# Power Flow

## Transfer Clutch Assembly

Rear View of Intermediate Case

Transfer Clutch Assembly

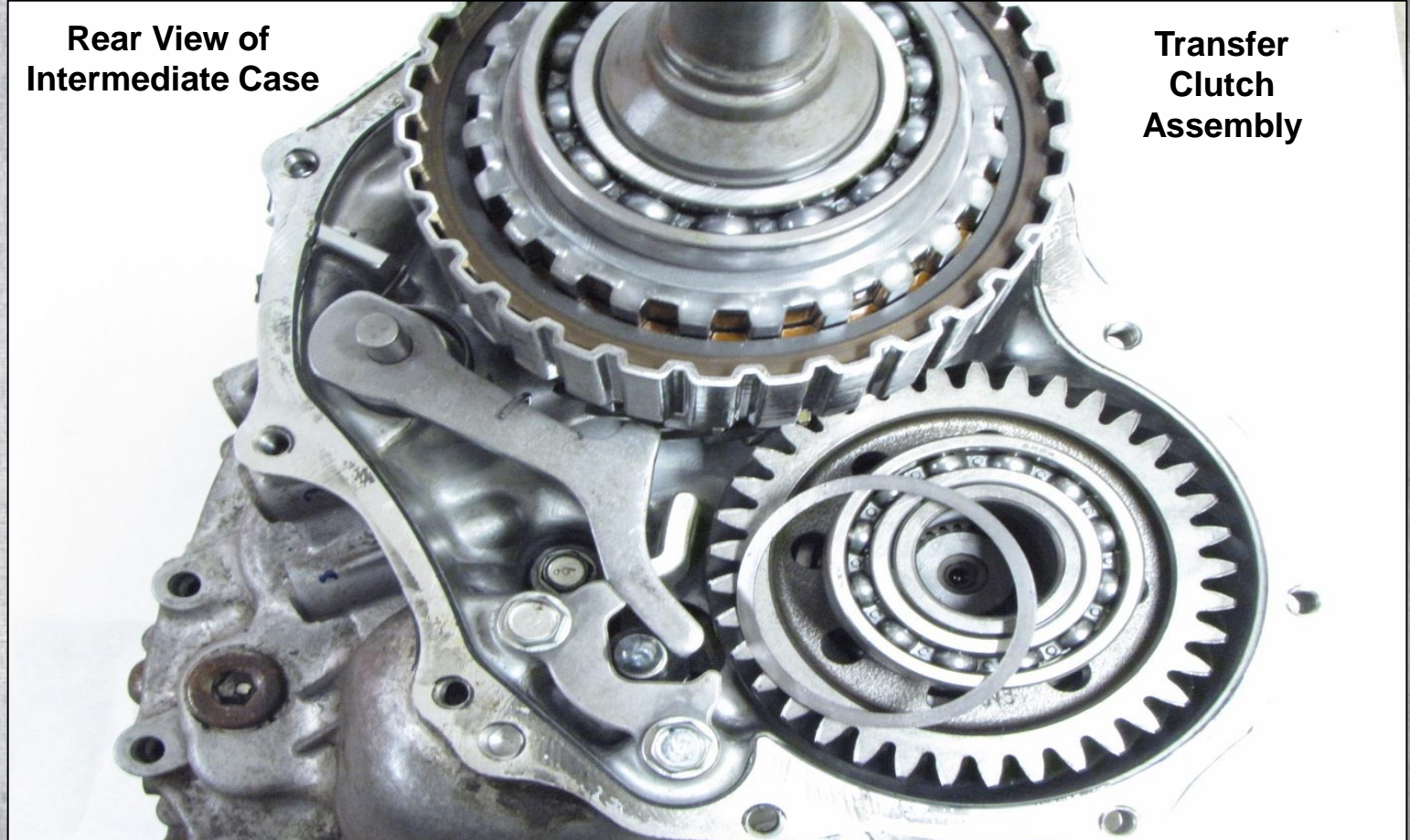

*your source for engineered solutions*





SEAL AFTERMARKET  
PRODUCTS



## Power Flow

### Transfer Clutch Assembly

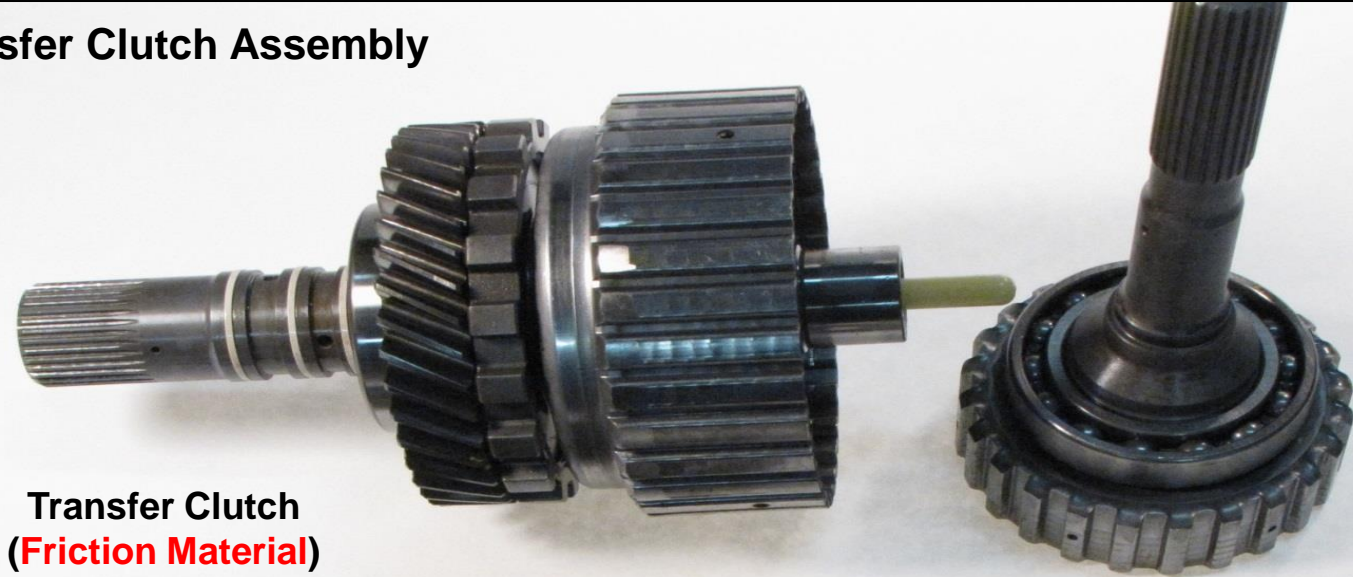

Transfer Clutch  
(Friction Material)



*your source for engineered solutions*





SEAL AFTERMARKET  
PRODUCTS



## Drain & Fill Main Case Gen I

### Fluid & Filter Replacement:

Remove the drain plug (Allen) on the Main Case Pan, drain all CVTF fluid out. Replace drain plug when fluid stops dripping. Remove pan and replace filter. Install pan using Red RTV sealant or equivalent.

Remove fill plug located on the back of the Intermediate case.

Add Subaru CVTF fluid until fluid starts to drip out.

Start the engine and monitor fluid temperature with a capable scan tool of until it reaches 86-104°F (30°-40°C).

Move the select lever from P - R, then N - D, again from D - N, next to R - P, while the engine is idling, to make the fluid circulate within the transmission.

Add fluid if necessary until fluid stops dripping out.

Replace gasket (seal) on Fill Plug and tighten to 36.9 ft. lb.



*your source for engineered solutions*





SEAL AFTERMARKET PRODUCTS



# Drain & Fill Main Case Gen I

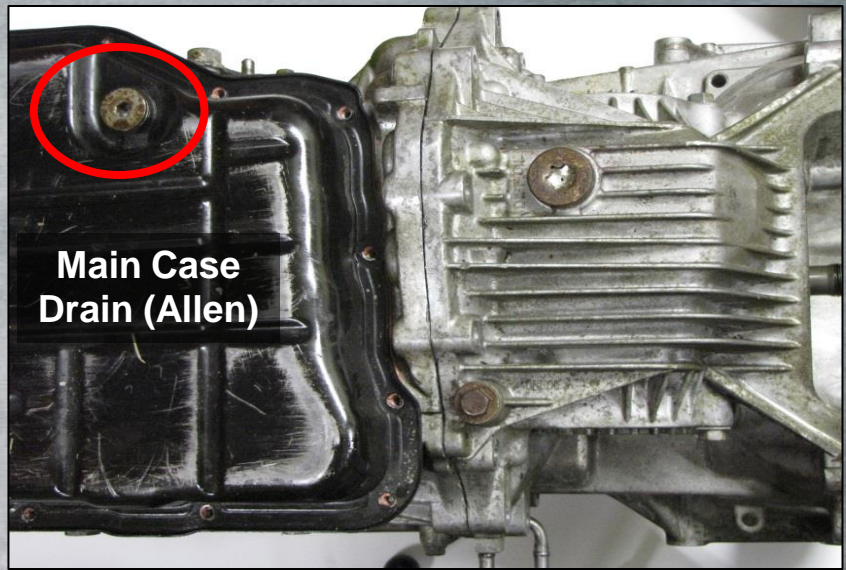
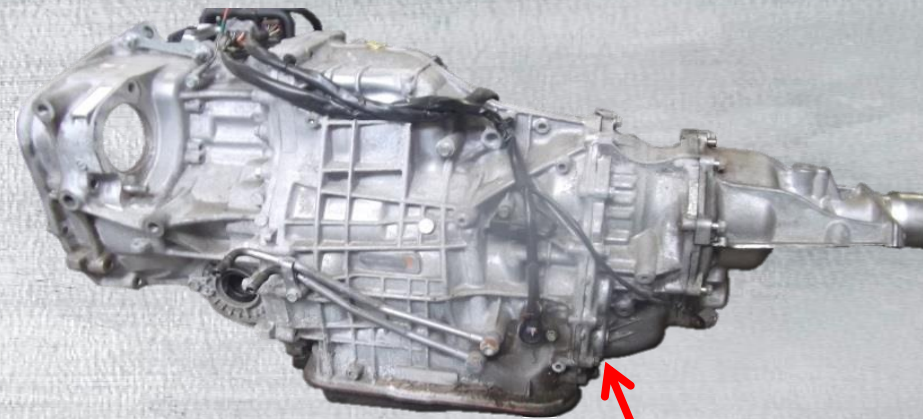

Main Case Drain (Allen)

Main Case Fill & Check Plug On Intermediate Case

Fill Until Oil Starts To Drip Out Of Hole at the correct temperature

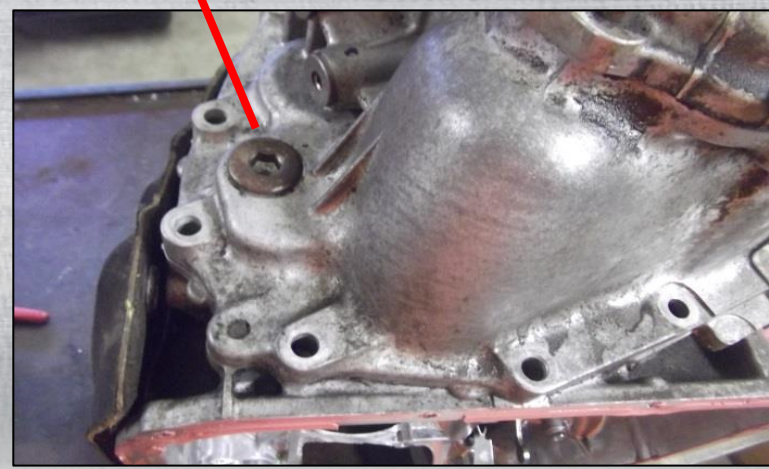

Fluid quantity L	11.3~11.8
US qt., Imp qt.	(11.9~12.5, 9.9~10.4)



*your source for engineered solutions*





SEAL AFTERMARKET  
PRODUCTS



## Drain & Fill Main Case Gen II

The Gen II fill plug (Allen) is located just above the pan rail on the left side of the transmission main case. Same procedure as the Gen I.

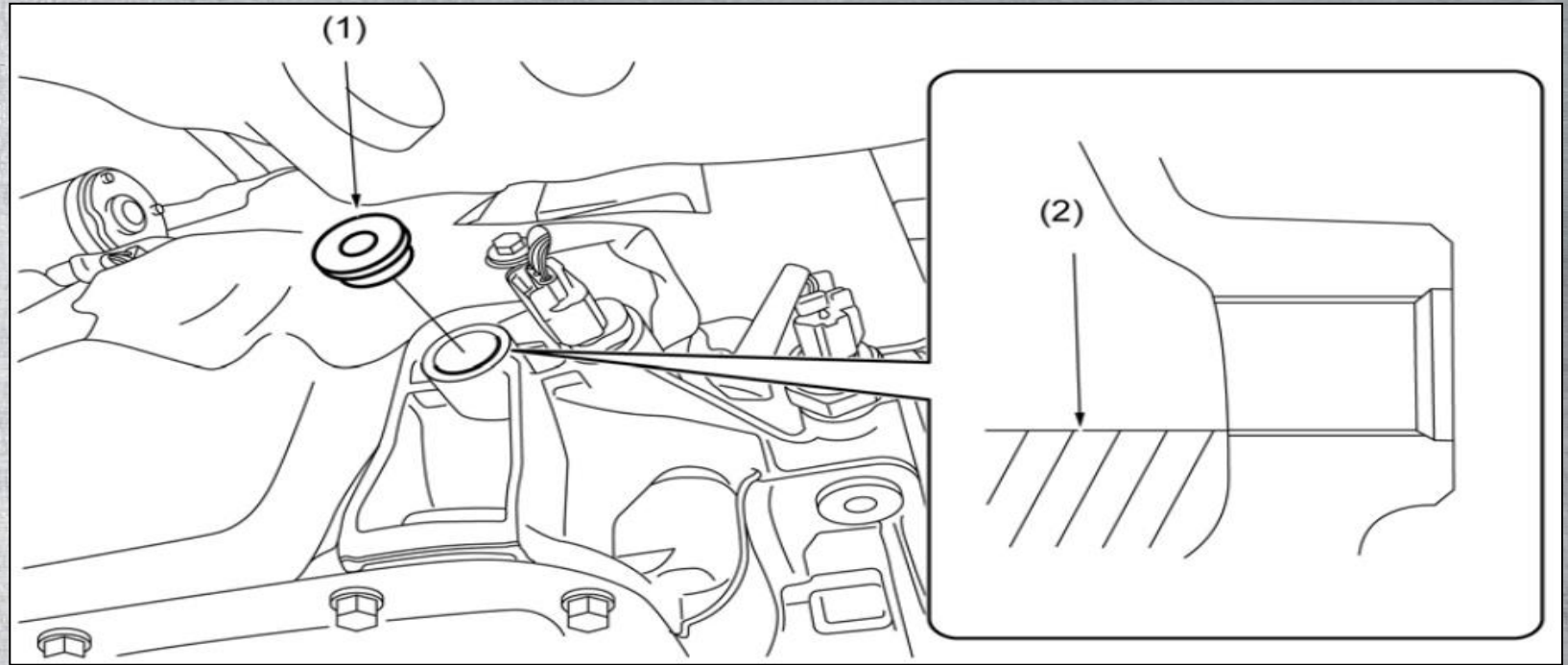

- 1 = Fill Plug
- 2 = Fluid Level (at correct temperature)



*your source for engineered solutions*





SEAL AFTERMARKET  
P R O D U C T S



## Drain & Fill Front Differential Gen I

### Gear Oil Replacement:

Remove the Drain Plug using a Torx bit # T70 on the bottom of the Front Differential. Drain all Gear Oil out.

Replace drain plug when Gear Oil stops dripping. Tighten to 51.6 ft.lb.

Remove the Check Plug plug located on the bottom of the Front Differential.

Add GL5 75W-90 Gear Oil through the vent tube hole with vent tube removed until fluid starts to drip out of Check Plug. Capacity 1.4-1.5 qt.

Replace the Check Plug.



*your source for engineered solutions*







# Drain & Fill Front Differential Gen I



**Most common failure no differential oil after being serviced at a quick lube facility**

**Vent Tube**

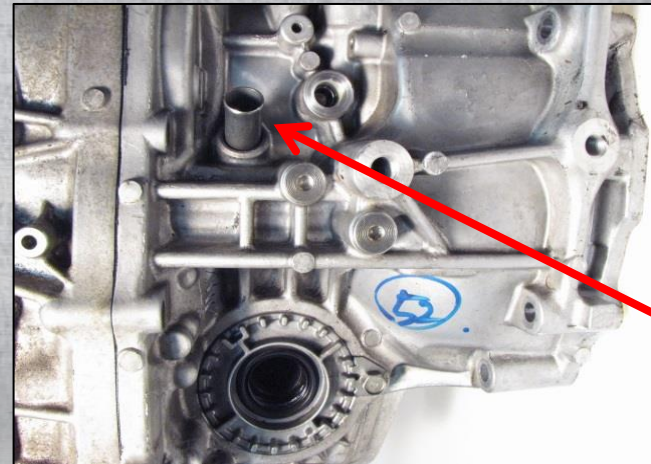
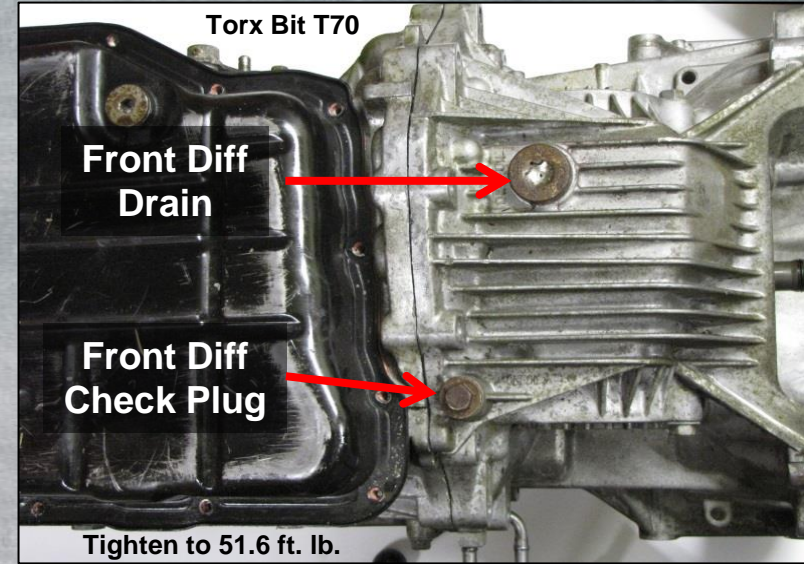

**Vent Tube Removed To Fill Until Oil Drips Out Of Check Plug**



*your source for engineered solutions*





SEAL AFTERMARKET  
PRODUCTS



## Drain & Fill Front Differential Gen II

The Gen II fill plug (Allen) is located on just above and to the left of the right side axle. Same procedure as the Gen I.

**Note:** There is a plug on the left side of the differential in the same area, but it goes to the pump of the transmission.

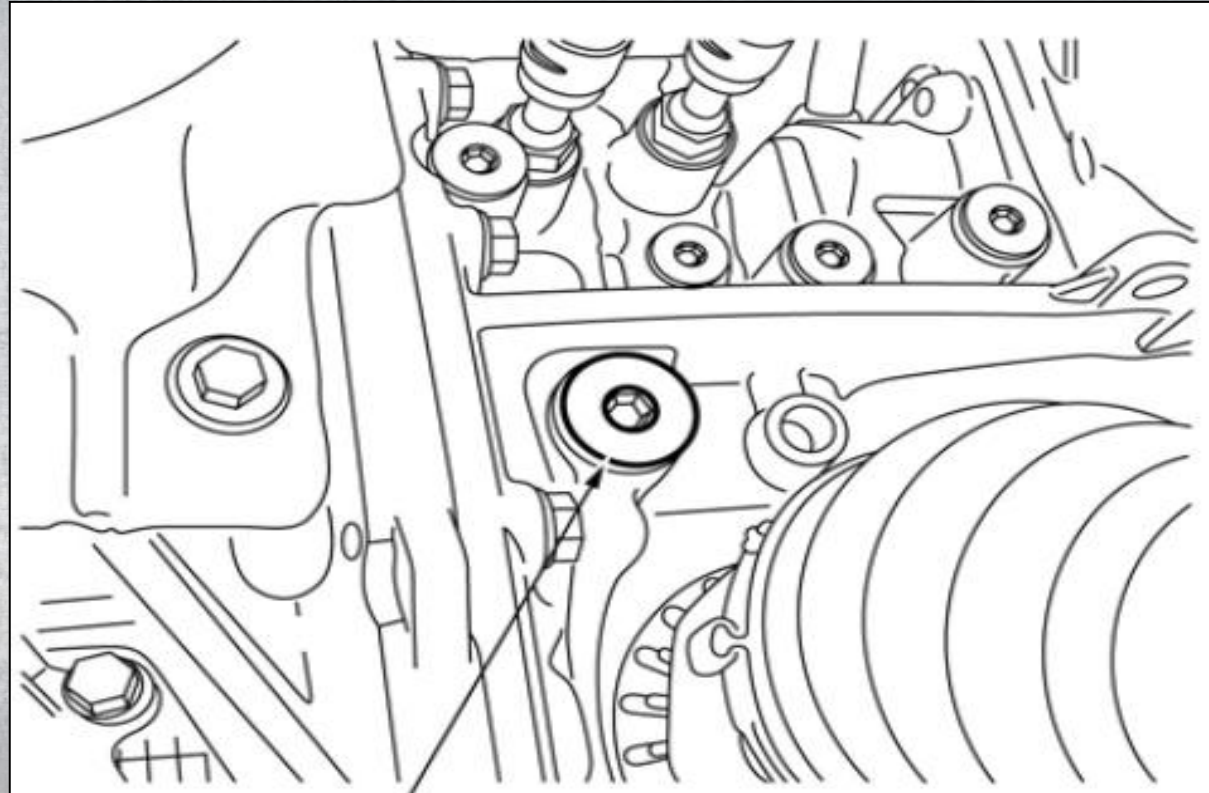

*your source for engineered solutions*





SEAL AFTERMARKET  
PRODUCTS



## Electronics

On top of the transmission are two main electrical connections.

Subaru calls the Black Connector the T3/B12 connector.

It contains wires for the;

- inhibitor switch
- primary speed sensor.

Subaru calls the Grey Connector the T4/B11 connector. It contains wires for;

- seven transmission solenoids
- temperature sensor
- front wheel speed sensor
- secondary speed sensor
- secondary pressure sensor
- sensor grounds.

These connectors are easy to reach while performing electrical tests.

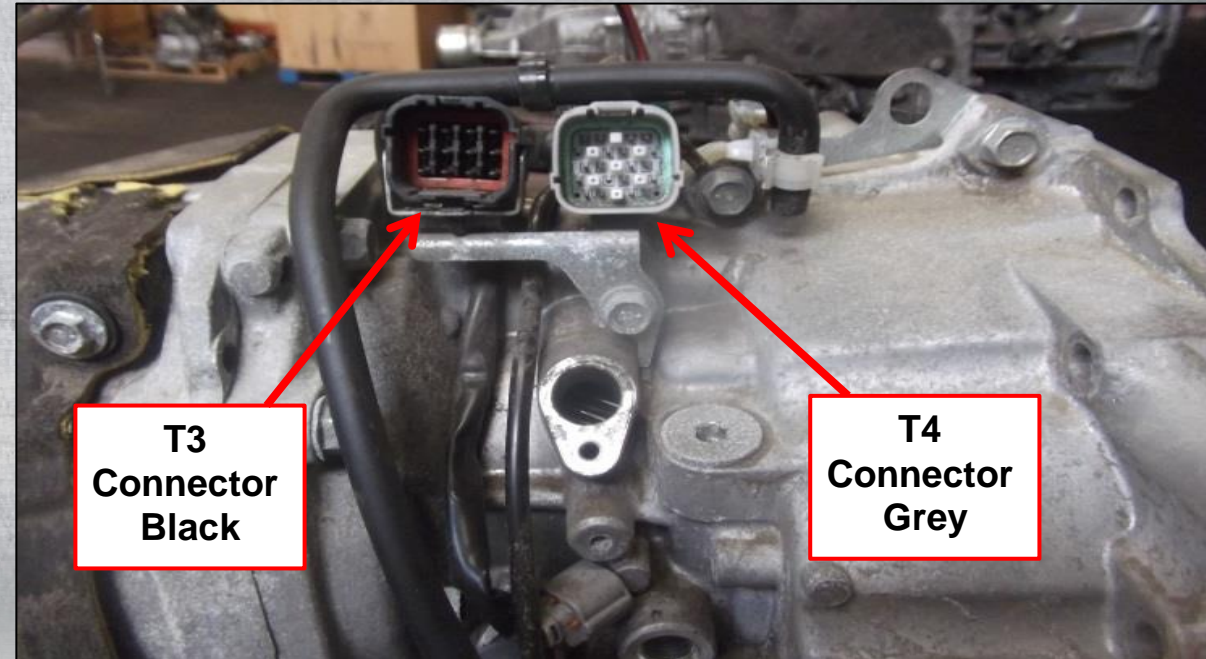

*your source for engineered solutions*





SEAL AFTERMARKET PRODUCTS



## Electronics

In-car testing of the Inhibitor Switch is easiest at the T3 black connector on top of bellhousing. This connector is in the middle of the main harness. Use the T3 connector as a guide for testing the inhibitor switch in the car.

Use the ranger sensor connector for the pin locations for bench testing. The chart identifies the wires and terminals at each connector.

Black T3/B12 Connector

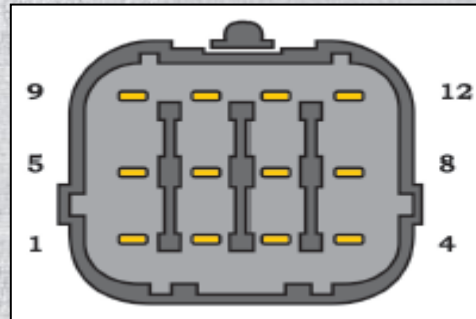

Inhibitor Switch (range sensor)

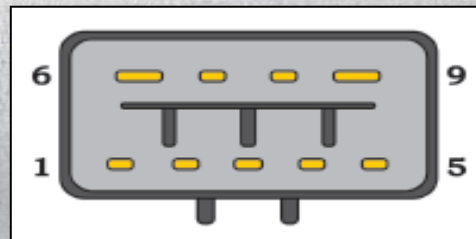

Range switch terminals and descriptions.		
T3 connector	Range sensor	Pin description
1	3	Neutral range
2	5	Reverse range
3	2	Park range
4	1	Common ground
5		Primary speed sensor power
6		Primary speed sensor signal
7		Primary speed sensor ground
8	4	Drive range
9	8	Reverse lights
10	7	Reverse lights
11	9	Starter system
12	6	Starter system



*your source for engineered solutions*





SEAL AFTERMARKET PRODUCTS



# Electronics

The last piece of information you need to test the Inhibitor Switch is shown below. To test the inhibitor switch at the T3/B12 black connector (much easier to gain access). It can also be tested at the range sensor connector on the bench.

Set your meter to check continuity and check for continuity between the terminals shown:

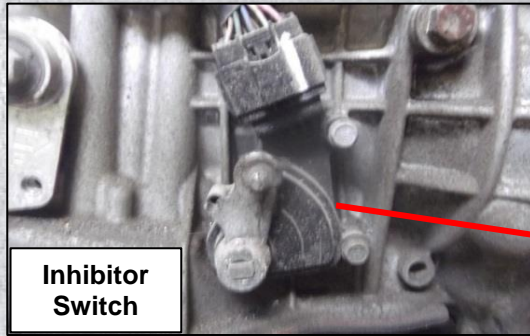

Inhibitor Switch

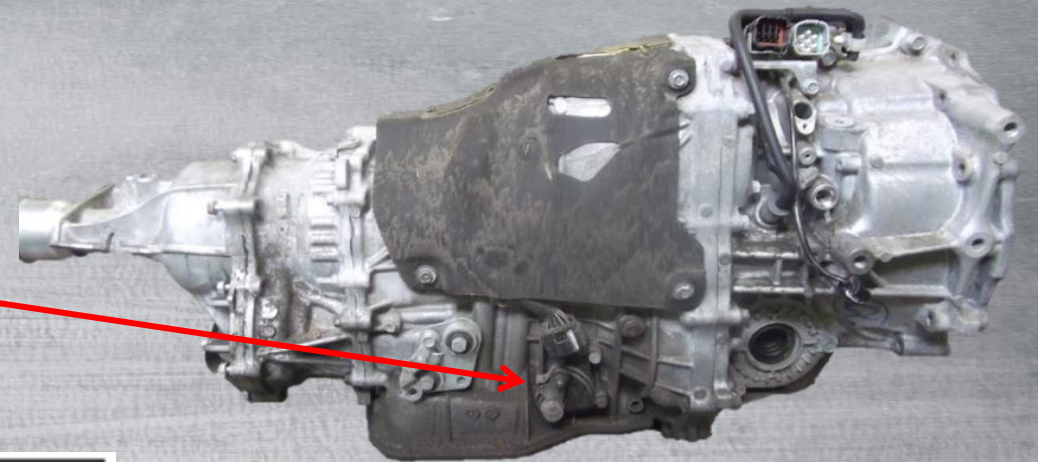

Inhibitor switch test				
Range	T3 connector		Range switch	
Park	4	3	2	1
Reverse	4	2	5	1
Neutral	4	1	3	1
Drive	4	8	4	1
Starter P/N	12	11	9	6
Back-up light	10	9	8	7

Black T3/B12 Connector

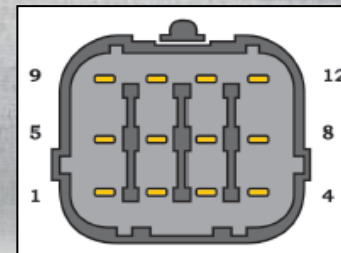

Inhibitor Switch (range sensor)

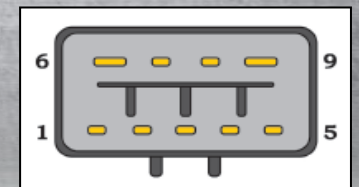

*your source for engineered solutions*





SEAL AFTERMARKET PRODUCTS



# Electronics

Test the transmission temperature sensor (integral to internal harness) at the T4/B11 grey connector: Set your meter to check resistance.

Connect the leads to terminals 19 and 16. You should have 2.5k ohms at 68°F (20°C) and 330 ohms at 176°F (80°C).

You can also check the solenoids resistances at the T4/B11 grey connector. The chart below provides all the solenoid values and pin numbers to check. All of the solenoids are normally grounded to the case, check the resistance between the terminal listed and a good chassis ground.

T4/B11 Grey Connector

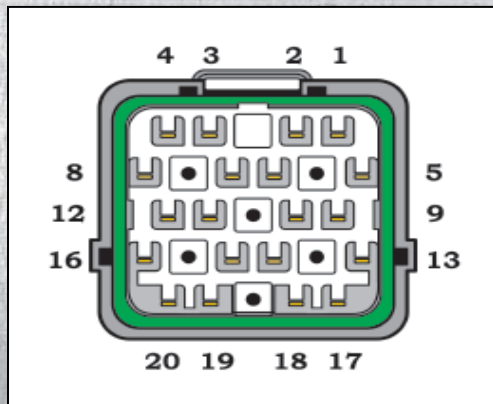

Solenoid Resistance

Solenoids	T4 connector	Resistance
Secondary	5 GND	5-7 ohms
Forward & Reverse	9 GND	4-6 ohms
Lock-up on/off	3 GND	15-17 ohms
Primary Down	1 GND	10-13.5 ohms
Primary Up	6 GND	10-13.5 ohms
Lock-up Duty	2 GND	10-13.5 ohms
AWD	4 GND	2-4.5 ohms



*your source for engineered solutions*





SEAL AFTERMARKET  
PRODUCTS



## Electronics

Here is a complete T4/B11 Grey connector pin identification chart.

1. Primary Down Solenoid
2. Lockup Duty Solenoid
3. Lockup On/Off Solenoid
4. AWD Solenoid
5. Secondary Solenoid
6. Primary Up Solenoid
7. Front Wheel Speed Sensor 12 Volts
8. Not Used
9. Forward/Reverse Solenoid
10. Secondary Speed Sensor Signal DC Hz
11. Secondary Speed Sensor 12 Volts
12. Front Wheel Speed Sensor Signal DC Hz
13. Front Wheel Speed Sensor Ground
14. Secondary Pressure Sensor Signal
15. Not Used
16. Temperature Sensor Ground (integral to internal harness)
17. Secondary Pressure Sensor 5 Volts
18. Secondary Pressure Sensor Signal
19. Temperature Sensor Ground (integral to internal harness)
20. Secondary Speed Sensor Ground

T4B11 Grey Connector

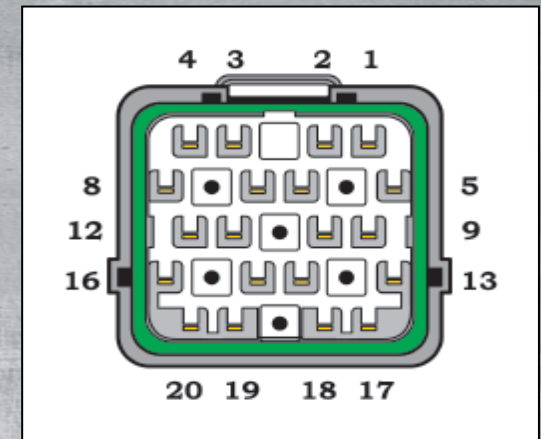



SEAL AFTERMARKET PRODUCTS



# Electronics

All of the solenoids are feed-controlled voltage by the TCM and grounded at the valve body.

The secondary linear control solenoid and forward/reverse solenoid are linear-style solenoids.

The lockup duty, primary-up, primary-down, and all wheel drive transfer clutch solenoids are PWM-controlled solenoids.

These solenoids are normally closed and are fully interchangeable.

The lockup on/off solenoid is the only on/off style solenoid in the unit, it's normally closed.

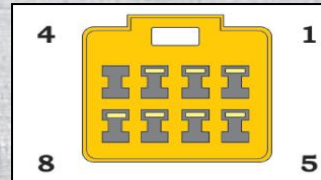

Internal Harness Connector

Solenoid Resistance Chart			
Solenoids	Valve Body Connector		Resistance
Secondary	1	GND	5-7 ohms
Forward & Reverse	3	GND	4-6 ohms
Lock-up on/off	5	GND	15-17 ohms
Primary Down	6	GND	10-13.5 ohms
Primary Up	7	GND	10-13.5 ohms
Lock-up Duty	2	GND	10-13.5 ohms
AWD	8	GND	2-4.5 ohms

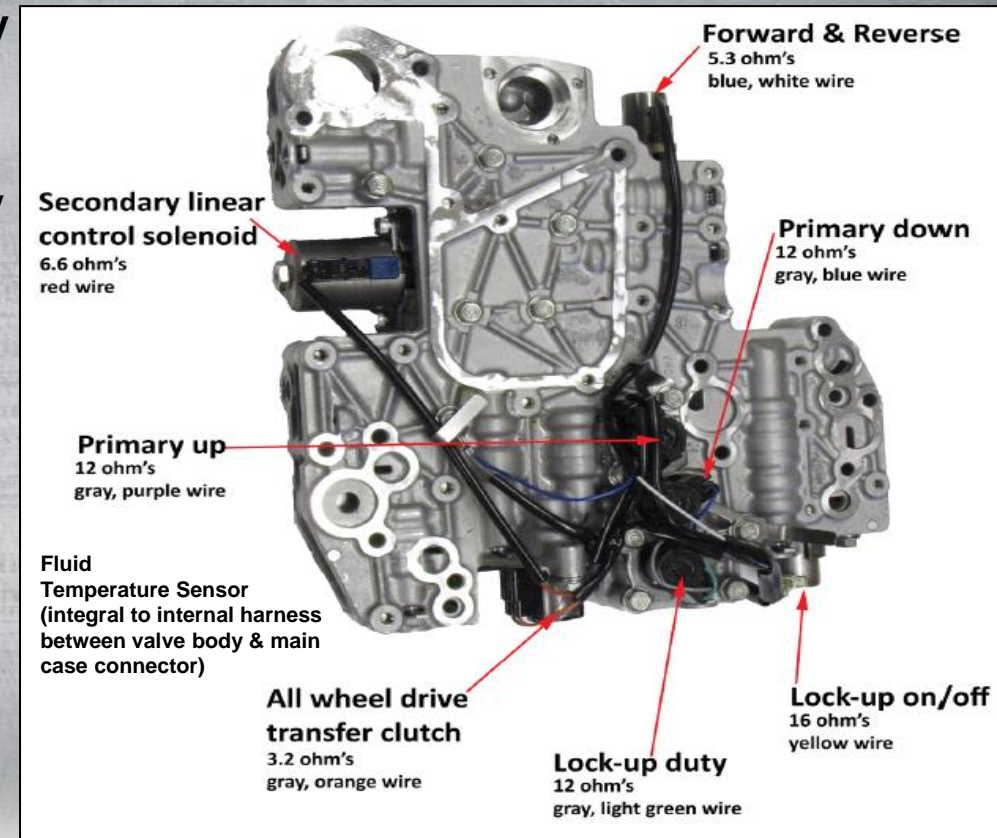

*your source for engineered solutions*







SEAL AFTERMARKET PRODUCTS



# Electronics

Primary Revolution Sensor is a Hall Effect 3 wire sensor and monitors Primary Pulley rotation. This sensor sends a DC Hz signal to the TCM.

The Secondary Oil Pressure Sensor is also a 3 wire Hall Effect and monitors the Secondary Pulley hydraulic circuit. Key on, engine off, zero volts Engine idling no load 0.5 volts Engine stall 4.5 volts

Primary Revolution Sensor

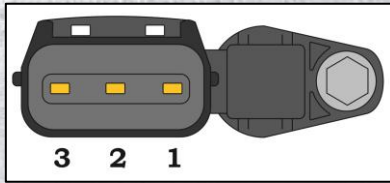

- 1 = 12 Volts
- 2 = Signal (5 Volts)
- 3 = Ground

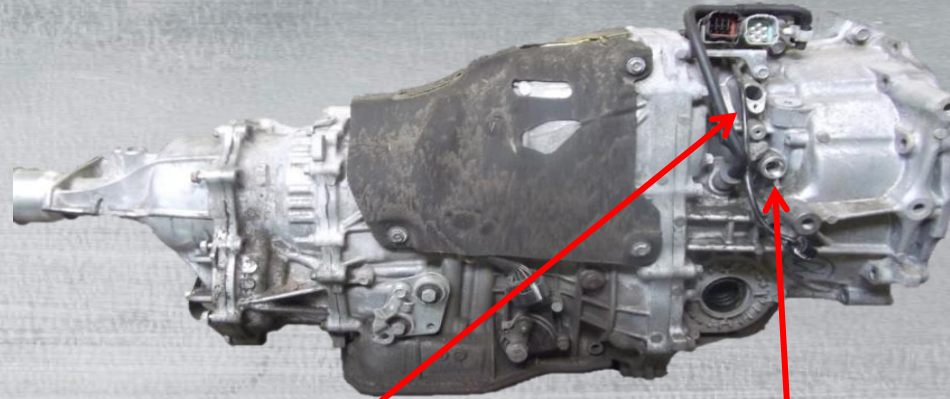

Secondary Oil Pressure Sensor



- 1 = 5 Volts
- 2 = Signal
- 3 = Ground

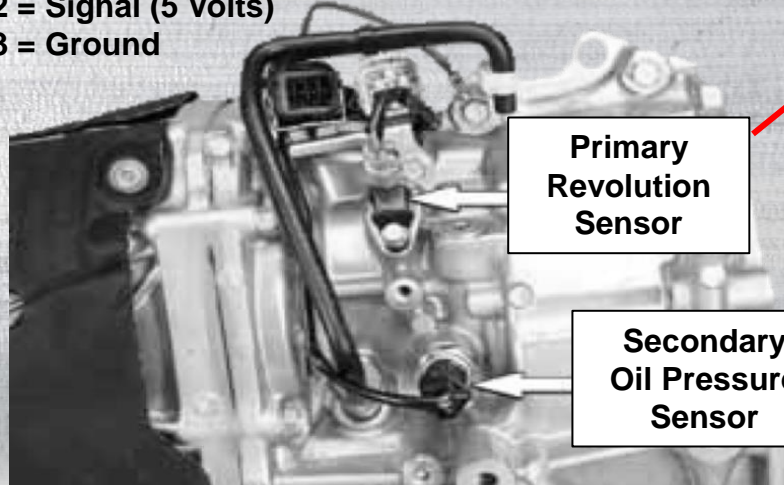

Primary Revolution Sensor

Secondary Oil Pressure Sensor

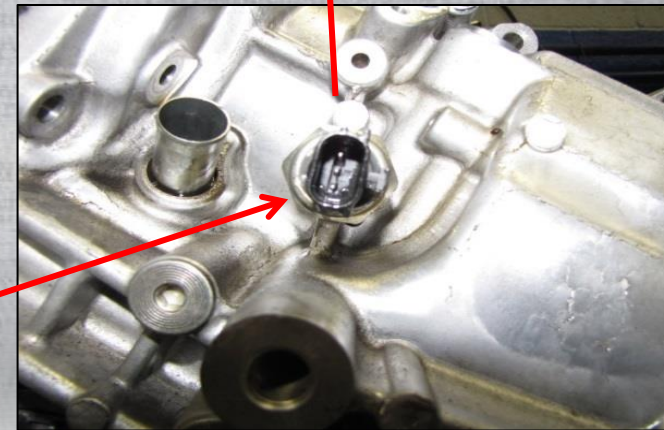

*your source for engineered solutions*





SEAL AFTERMARKET PRODUCTS



# Electronics

Secondary Revolution Sensor is a Hall Effect 3 wire sensor and monitors Secondary Pulley rotation. This sensor sends a DC Hz signal to the TCM.

The Front Wheel Speed Sensor is also a 3 wire Hall Effect and monitors the Transfer Driven gear which makes this an Output Speed Sensor. This sensor also sends a DC Hz signal to the TCM.

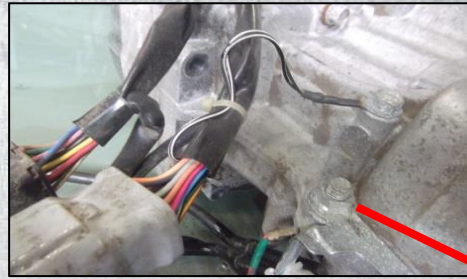

Ground Wire

Secondary Revolution Sensor

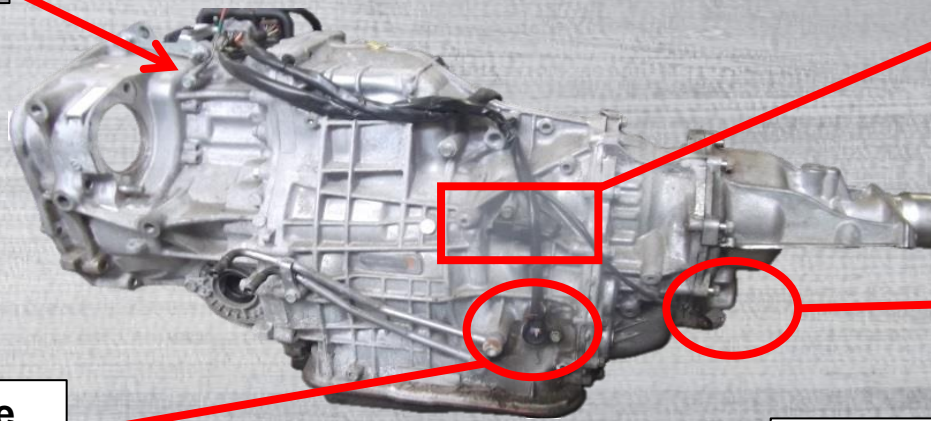

Control Valve Body Harness

Front Wheel Speed Sensor

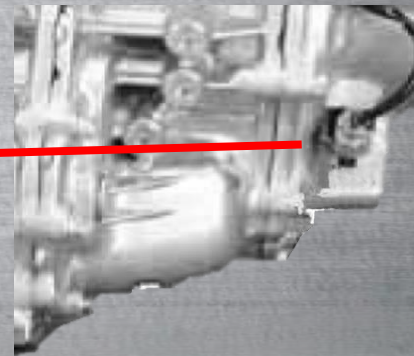

*your source for engineered solutions*





SEAL AFTERMARKET PRODUCTS



*your source for engineered solutions*



## Electronics

### TCM Terminal Identification.

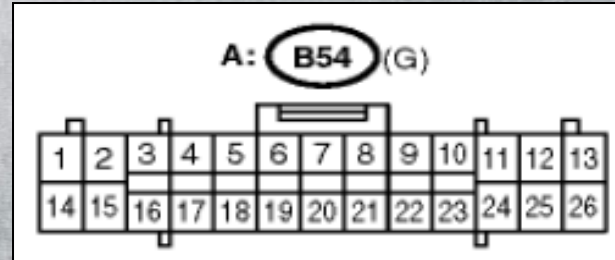

- 1 - TCM Ground
- 2 - Secondary Pressure Sensor Power Supply
- 3 - ATF Temperature Sensor Signal
- 4 - Not Used
- 5 - Inhibitor Switch "Park" Range
- 6 - Primary Speed Sensor Signal
- 7 - Secondary Speed Sensor Signal
- 8 - Not Used
- 9 - Inhibitor Switch "Neutral" Range
- 10 - Not Used
- 11 - Forward & Reverse Linear Solenoid
- 12 - Secondary Linear Solenoid
- 13 - All Wheel Drive Solenoid
- 14 - Secondary Speed Sensor Ground
- 15 - Secondary Pressure Sensor Ground
- 16 - ATF Temperature Sensor Ground
- 17 - Secondary Pressure Sensor Signal
- 18 - Inhibitor Switch "Reverse" Range
- 19 - Not Used
- 20 - Front Wheel Speed Sensor Signal
- 21 - Not Used
- 22 - Inhibitor Switch "Drive" Range
- 23 - Lock-Up Solenoid (On/Off)
- 24 - Primary UP Duty Solenoid
- 25 - Primary DOWN Duty Solenoid
- 26 - Lock-Up Duty Solenoid

Note: Year make and models may vary, always check wire diagram resources for the vehicle being worked on.



SEAL AFTERMARKET PRODUCTS



# Electronics

## TCM Terminal Identification connector B (B55).

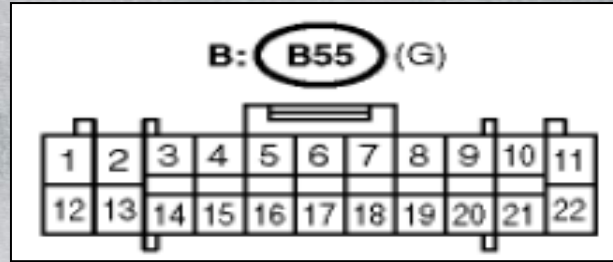

- 1 - Backup Power Supply
- 2 - Main Power Supply
- 3 - Not Used
- 4 - Manual Mode Switch
- 5 - Manual Mode UP Switch
- 6 - Not Used
- 7 - Not Used
- 8 - Not Used
- 9 - Not Used
- 10 - Not Used
- 11 - Main Power Supply

- 12 - Not Used
- 13 - Stop Light Switch Input
- 14 - Not Used
- 15 - Not Used
- 16 - Manual Mode DOWN Switch
- 17 - CAN Communication Line (-)
- 18 - CAN Communication Line (+)
- 19 - Data Link Signal
- 20 - Self-Shut Relay
- 21 - Ignition Supply Voltage
- 22 - Main Power Supply



*your source for engineered solutions*



# Diagnostic Trouble Codes



SEAL AFTERMARKET  
PRODUCTS



DTC	Item	Definition
P0705	Transmission Range Sensor Circuit	(PRNDL Input) Inhibitor switch malfunction or short circuit
P0708	AT Range Switch Not Inputted	Inhibitor switch malfunction or open circuit
P0712	Transmission Fluid Temperature Sensor Circuit Low Input	ATF temperature sensor is faulty or input signal circuit is shorted.
P0713	Transmission Fluid Temperature Sensor Circuit High Input	ATF temperature sensor is faulty or input signal circuit is open or shorted.
P0719	Brake Switch Circuit Low	Brake switch malfunction, open or shorted input signal circuit
P0720	Output Speed Sensor Circuit	Front wheel speed sensor is faulty or input signal circuit is open
P0724	Brake Switch Circuit High	Brake switch malfunction, shorted input signal circuit
P0730	Gearshift Control Performance Abnormal	Primary speed sensor, secondary speed sensor, control valve, or chain malfunction
P0801	Reverse Inhibit Control Circuit	Shift lock solenoid is faulty or output signal circuit is open or shorted.
P0841	Secondary Oil Pressure Sensor Performance	Secondary pressure sensor or control valve malfunction
P0842	Secondary Oil Pressure Sensor Circuit (Low)	Secondary pressure sensor is faulty or input signal circuit is open or shorted.
P0843	Secondary Oil Pressure Sensor Circuit (High)	Secondary pressure sensor is faulty or input signal circuit is shorted.
P0890	AT Self Shut Relay Diagnosis (Low)	Self shut relay malfunction, open or shorted input signal circuit
P0951	Manual Switch	Manual mode switch malfunction, open or shorted input signal circuit
P0962	Secondary Solenoid Circuit (Low)	Secondary solenoid is faulty or output signal circuit is shorted.



*your source for engineered solutions*



# Diagnostic Trouble Codes



SEAL AFTERMARKET  
PRODUCTS



P0963	Secondary Solenoid Circuit (High)	Secondary solenoid is faulty or output signal circuit is open or shorted.
P0965	Forward & Reverse Solenoid Function	F & R solenoid, forward clutch or control valve malfunction
P0966	Forward & Reverse Solenoid Circuit (Low)	F & R solenoid is faulty or output signal circuit is shorted.
P0967	Forward & Reverse Linear Solenoid Circuit (High)	F & R solenoid is faulty or output signal circuit is open or shorted.
P0970	Transfer Solenoid Circuit (Low)	AWD solenoid is faulty or output signal circuit is shorted.
P0971	Transfer Solenoid Circuit (High)	AWD solenoid is faulty or output signal circuit is open or shorted.
P0973	Primary Solenoid System A Circuit (Low)	Primary UP solenoid is faulty or output signal circuit is shorted.
P0974	Primary Solenoid System A Circuit (High)	Primary UP solenoid is faulty or output signal circuit is open or shorted.
P0976	Primary Solenoid System B Circuit (Low)	Primary DOWN solenoid is faulty or output signal circuit is shorted.
P0977	Primary Solenoid System B Circuit (High)	Primary DOWN solenoid is faulty or output signal circuit is open or shorted.
P1718	AT CAN Communication Circuit	CAN communication is open or shorted. ECM, ABS/VDCCM CAN communication error
P1724	AT EEPROM Error	TCM EEPROM malfunction
P1725	AT Body System CAN Communication Trouble	Combination meter, A/C, body integrated unit CAN communication error
P2746	Primary Pulley Revolution Speed Sensor Circuit	Primary speed sensor malfunction, open or shorted input signal circuit
P2750	Sec. Pulley Revolution Speed Sensor Circuit	Secondary speed sensor malfunction, open or shorted input signal circuit
P2762	Lock Up Duty Solenoid Malfunction	Lockup duty solenoid, lockup clutch or control valve malfunction
P2763	Lock Up Duty Solenoid Circuit (High)	Lockup duty solenoid is faulty or output signal circuit is open or shorted.



*your source for engineered solutions*





SEAL AFTERMARKET  
PRODUCTS



## Diagnostic Trouble Codes

P2764	Lock Up Duty	Lockup duty solenoid is faulty Solenoid Circuit (Low) output signal circuit is shorted.
P2769	Lock Up ON/OFF Solenoid Circuit (Low)	Lockup ON/OFF solenoid is faulty or output signal circuit is shorted.
P2770	Lock Up ON/OFF Solenoid Circuit (High)	Lockup ON/OFF solenoid is faulty or output signal circuit is open or shorted.



*your source for engineered solutions*





SEAL AFTERMARKET PRODUCTS



# Lockup TSB

Name	Value
Engine Speed (rpm)	1121
Battery Voltage (V)	14.2
Accelerator Position (%)	0
Front Wheel Speed (mph)	12
Automatic Transmission Fluid Temperature (°F)	87
Lock Up Duty Ratio (%)	36
Transfer Duty Ratio (%)	30
Actual Secondary Pressure (psi)	0.152
Secondary Solenoid Set Current (mA)	692
Secondary Solenoid Actual Current (mA)	699
Commanded Forward And Reverse Linear Solenoid Current (mA)	811
Actual Forward And Reverse Linear Solenoid Current (mA)	812
Primary Pulley Speed (rpm)	949
Secondary Pulley Speed (rpm)	732
Primary Up Duty (%)	0
Primary Down Duty (%)	58.4
Actual Gear Ratio	1.29

Lockup Apply at 36% as low as 12 mph

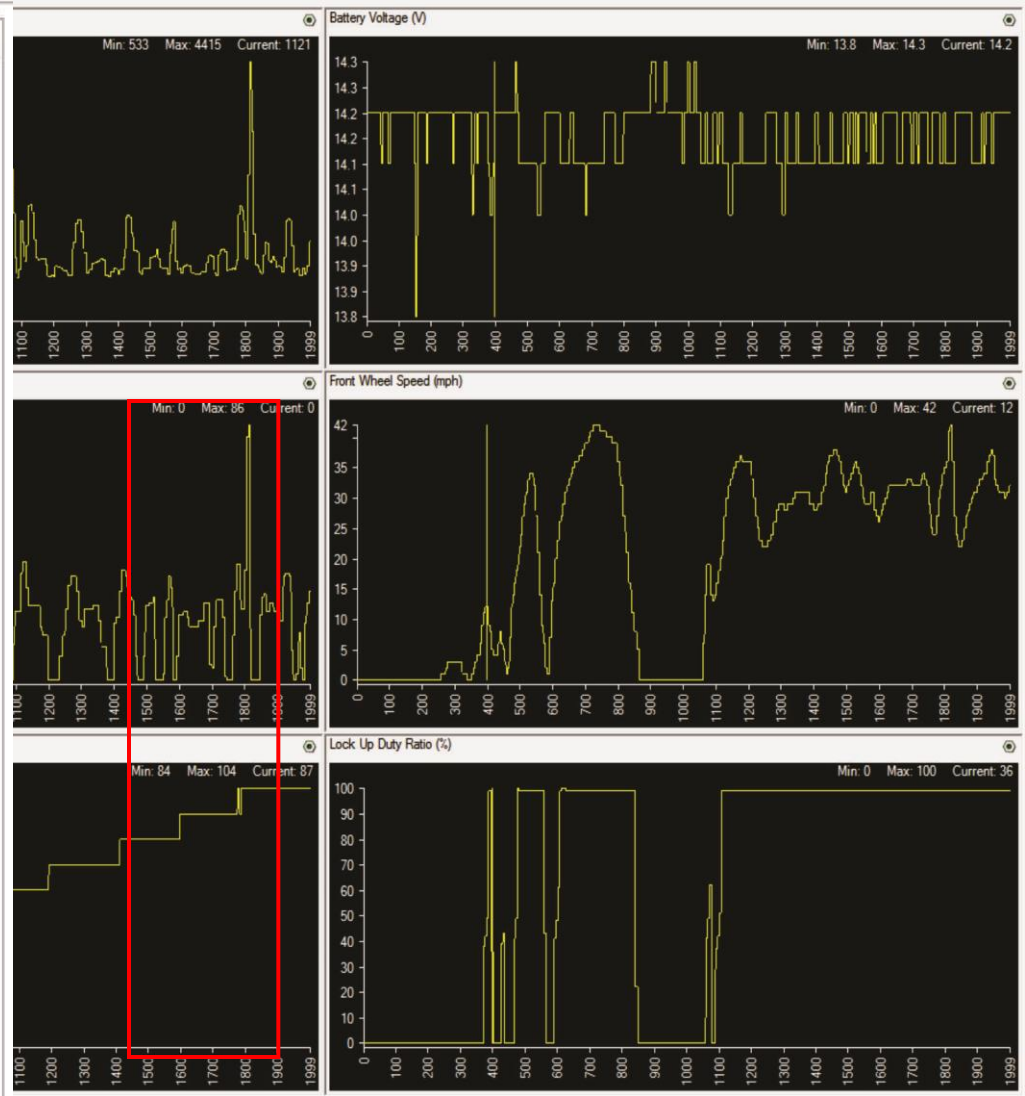

*your source for engineered solutions*







SEAL AFTERMARKET PRODUCTS



# Lockup TSB

## 2011 Subaru Legacy F4-2.5L SOHC

Vehicle » Transmission and Drivetrain » Continuously Variable Transmission/Transaxle » Technical Service Bulletins » All Technical Service Bulletins » CVT - Low Engine RPM When Coming to a Stop

NUMBER: 16-90-13

DATE: 01/06/14

### APPLICABILITY:

2010-12 MY Legacy and Outback Models Equipped with CVT Transmission

### SUBJECT:

Design Change to Lock-Up Type Torque Converter

PART NUMBER	DESCRIPTION	QUANTITY
31100AB171	Torque Converter Assy.	1
806735290	Differential Side Seal (L/H)	1
806735300	Differential Side Seal (R/H)	1
28333SA000	Axle Shaft C-Clip	2
SOA635043	CVT Fluid (Quart)	4

### INTRODUCTION

This bulletin announces the availability of a countermeasure **torque converter** assembly to address a customer concern of very low engine RPM when coming to a stop. The condition is similar to coming to a stop in a manual transmission equipped vehicle without depressing the clutch pedal. Thrust washer wear inside the torque converter can cause restriction of the oil passage used to bleed off lock-up **clutch** application pressure. The result is either a delayed (momentary low engine rpm) or no lock-up pressure release. The thrust washer has been changed from a solid bushing-type to a needle bearing type.

### COUNTERMEASURE IN PRODUCTION

The countermeasure **torque converter** was incorporated into production October 1, 2013 starting with transmission # 633208. Remanufactured CVT assemblies with a production date of 12/31/2013 or later as indicated on the shipping container label include this revised torque converter.



*your source for engineered solutions*





SEAL AFTERMARKET  
PRODUCTS

**TK** TOLEDO  
TRANS-KIT

**GEARS**  
FOR THE TRANSMISSION REBUILDING INDUSTRY

**WIT**  
WHATEVER IT TAKES  
TRANSMISSION PARTS, INC

# Lockup TSB

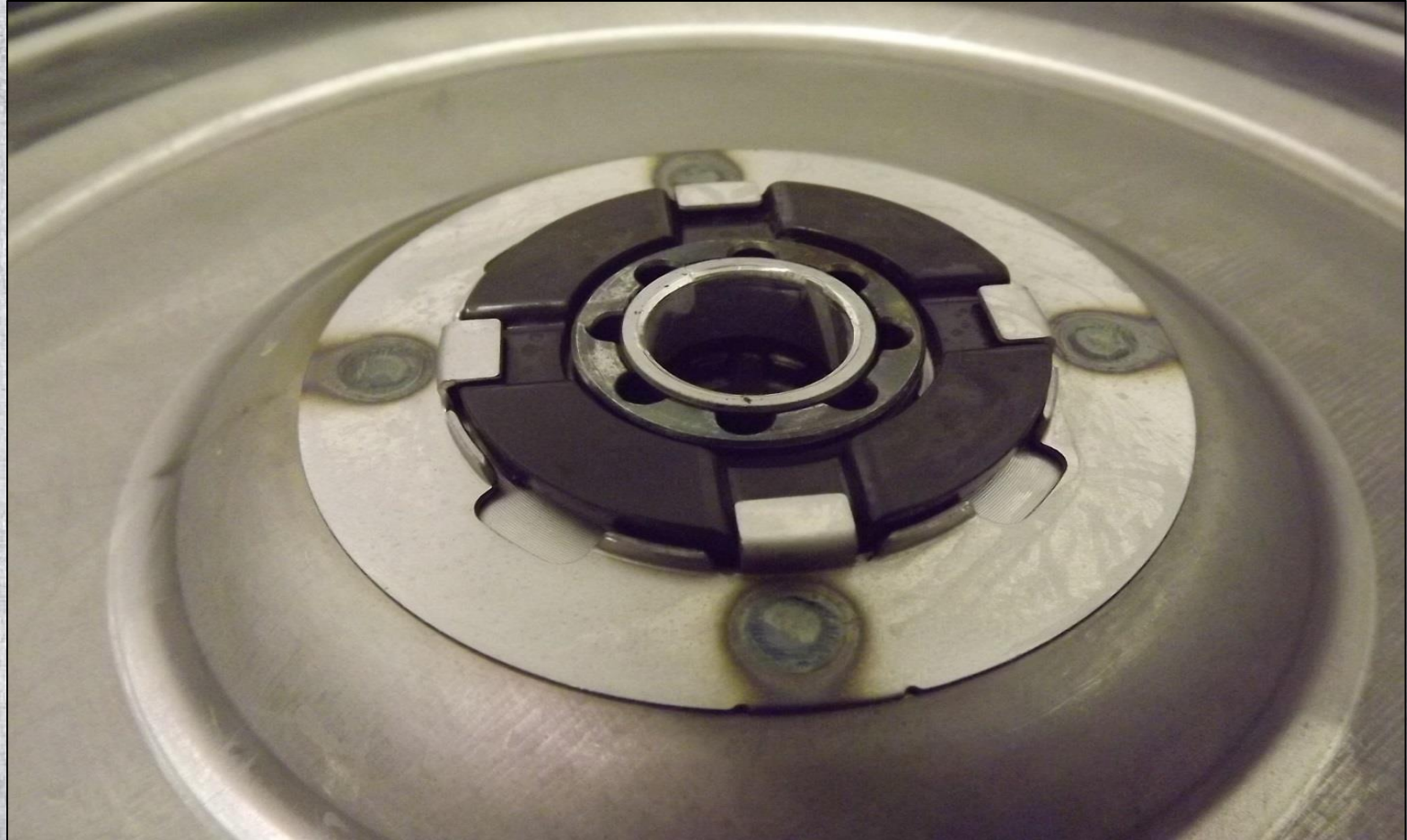

**TK** TOLEDO  
TRANS-KIT

*your source for engineered solutions*

SEAL AFTERMARKET  
PRODUCTS



SEAL AFTERMARKET  
P R O D U C T S



## Lockup TSB

- ^ Always verify the customer concern before proceeding with any diagnostics and / or repairs.
- ^ Diagnose any stored DTCs per the applicable Service Manual.
- ^ Perform a line pressure test to rule out other possible pressure-related causes for the condition.
- ^ After performing the applicable diagnostics, replace the torque converter assembly following the procedure outlined in the appropriate Service Manual.
- ^ Both front differential side (axle shaft) oil seals and axle shaft c-clips are one-time use items and must be replaced as part of this repair.
- ^ In rare instances, should the condition persist after replacing the torque converter, the valve body assembly may also require replacement.
- ^ Before releasing the vehicle, always confirm the CVT has been refilled to the proper level by following the procedure outlined in the appropriate Service Manual.

### REMINDER:

In the event the valve body requires replacement, the Learning Control procedure must be performed after installation to complete the repair.



*your source for engineered solutions*

